

APPENDIX C

Eightmile Lake Storage Restoration Feasibility Study



April 2018
Icicle Creek Water Resource Management Strategy



Eightmile Lake Storage Restoration Feasibility Study

Prepared for:
Icicle and Peshastin Irrigation Districts
Chelan County Natural Resources Department

Ecology Grant No. WROCR-VER1-ChCoNR-00002



April 2018
Icicle Creek Water Resource Management Strategy

Eightmile Lake Storage Restoration Feasibility Study

Prepared for

Icicle and Peshastin Irrigation Districts
P.O. Box 371
5594 Wescott Drive
Cashmere, Washington 98815

Chelan County Natural Resources Dept.
411 Washington Street, Suite 201
Wenatchee, Washington 98801

Prepared by

Anchor QEA, LLC
720 Olive Way, Suite 1900
Seattle, Washington 98101

Aspect Consulting, LLC
23 South Mission St.
Wenatchee, Washington 98801

TABLE OF CONTENTS

Executive Summary.....	E-1
1 Introduction	1
1.1 Compatibility with Icicle Strategy	1
1.2 Project Background	2
1.2.1 Prior Studies and Related Documents	5
1.3 Feasibility Study Description.....	7
1.3.1 Scope of Work.....	7
1.3.2 Purpose and Objectives	8
1.4 Report Organization.....	8
1.5 Feasibility-level Design Drawings	9
2 Existing Reservoir Conditions	11
2.1 Dam and Embankment	11
2.2 Low-Level Outlet Pipeline and Gate.....	14
2.3 Overflow Channel to Eightmile Creek	15
2.4 Useable Storage Capacity	15
2.5 Topography	17
2.6 Geology.....	17
2.7 Existing Reservoir Operations.....	18
2.8 Challenges, Deficiencies, and Constraints	20
3 Eightmile Lake Hydrology	21
3.1 Dam Safety Review	21
3.2 Watershed Description.....	22
3.3 Watershed Yield.....	23
3.4 Downstream Hazard Analysis.....	24
3.5 Design Storm Calculation.....	25
3.5.1 Identify Climatic Region.....	26
3.5.2 Estimate Mean Annual Precipitation.....	26
3.5.3 Estimate L-Moment Statistics	26
3.5.4 Calculate Mean At-Site Precipitation.....	26
3.5.5 Calculate Base Precipitation Values.....	26
3.5.6 Scaling Precipitation Estimates	27
3.5.7 Calculate Total Storm Precipitation.....	28

3.5.8	Calculate Peak Rainfall Intensity	29
3.5.9	Calculate Snowmelt Contribution	29
3.5.10	Calculate Design Storm Hyetograph	30
3.6	Design Storm Hydrologic Analysis	31
3.6.1	Methodology	31
3.6.2	Soil Characteristics and Land Cover	32
3.6.3	Land Cover and Curve Number	33
3.6.4	Estimated Inflow from Design Storm.....	33
3.6.5	Comparison to USGS Methodology.....	34
4	Eightmile Lake Storage Restoration Design	36
4.1	Design Criteria.....	36
4.2	Site Preparation	36
4.3	Dam and Embankment Restoration.....	37
4.3.1	Central Dam and Flow/Level Control.....	37
4.3.2	Primary Spillway Section.....	38
4.3.3	Secondary Spillway Section	38
4.4	Spillway Analysis and Design.....	38
4.4.1	Reservoir Storage and Spillway Dimensions.....	38
4.4.2	Spillway Discharge Calculations.....	39
4.4.3	Inflow Routing Calculation.....	39
4.4.4	Inflow Design Flood Selection.....	45
4.5	Low-level Outlet Pipe, Valves, and Release Controls	45
4.5.1	Hydraulic Analysis	47
4.6	Reservoir Operations	48
4.7	Restored Useable Storage Capacity.....	49
5	Construction Approach	52
5.1	Constraints and Limitations.....	52
5.2	Access and Mobilization.....	52
5.3	Access Options.....	52
5.3.2	Comparison.....	55
5.4	Materials Delivery and Staging.....	55
5.5	Construction Sequence and Scheduling	57
6	Cost Analysis	58
6.1	Summary of Probable Implementation Costs.....	58

6.2	Helicopter Mobilization and Rental	59
6.3	Long-term Operating Costs	59
7	Water Rights	61
7.1	History	61
7.2	Water Right Change Strategy and Process	63
8	Environmental and Permitting Strategy	64
8.1	Affected Environment and Anticipated Impacts	64
8.1.1	Geology	64
8.1.2	Water Resources and Water Use	65
8.1.3	Aquatic Habitat and Species	65
8.1.4	Vegetation	66
8.1.5	Wildlife	67
8.1.6	Cultural Resources	68
8.2	Anticipated Permitting Requirements	69
8.3	Recommended Permitting Approach	73
9	Summary and Recommendations	75
9.1	Summary of Proposed Improvements	75
9.2	Recommended Next Steps	76
10	References	78

TABLES

Table 1-1	Prior Studies and Related Documents	5
Table 2-1	Lake Volume Summary (From 2014 Forsgren Associates, Inc./Gravity Consulting, LLC Study)	16
Table 2-2	Lake Volume Summary (Based on Additional Data Collection)	17
Table 3-1	Eightmile Lake Drainage Area and Estimated Watershed Yield	24
Table 3-2	Results of Precipitation Frequency Analysis	27
Table 3-3	Total Precipitation for Design Storms	28
Table 3-4	Peak Storm Intensities for Design Storms	29
Table 3-5	Snowmelt Contribution for Design Storms	30
Table 3-6	Estimated Inflow from Design Storm	34
Table 4-1	Spillway Dimensions and Characteristics	39
Table 4-2	Elevation – Area – Storage Relationship Above Primary Spillway	41

Table 4-3	Spillway Outflow Summary for Potential Inflow Design Storms.....	45
Table 4-4	Low-level Outlet Pipeline Analysis.....	48
Table 4-5	Anticipated Reservoir Operations.....	49
Table 5-1	Potential Construction Access and Mobilization Approach Comparison.....	55
Table 6-1	Opinion of Probable Project Implementation Costs	58
Table 6-2	Likely Helicopter Mobilization and Rental Costs.....	59
Table 8-1	Anticipated Eightmile Lake Storage Restoration Project Permitting Requirements..	70

FIGURES

Figure 1-1	Location Map	3
Figure 1-2	Photo-realistic Rendering of Proposed Eightmile Lake Improvements.....	10
Figure 2-1	Eightmile Lake Drainage Basin	12
Figure 2-2	Eightmile Lake Drainage Basin Geology Map	19
Figure 3-1	Design Storm (Step 8) Hyetographs.....	31
Figure 3-2	HEC-HMS Sub-basin Delineation.....	32
Figure 3-3	Design Storm (Step 8) Inflow Hydrographs	35
Figure 4-1	Proposed Eightmile Lake Stage-Storage Curve.....	40
Figure 4-2	Short-Duration Storm, Inflow-Outflow Relationship.....	42
Figure 4-3	Intermediate-Duration Storm, Inflow-Outflow Relationship	43
Figure 4-4	Long-Duration Storm, Inflow-Outflow Relationship	44
Figure 4-5	Eightmile Lake Water Surface Area Comparison	51

APPENDICES

Appendix A	Feasibility-Level Drawings
Appendix B	Photographs
Appendix C	Downstream Hazard Analysis Worksheet
Appendix D	Precipitation Data Lookup Worksheets
Appendix E	Snowmelt Calculation Worksheet
Appendix F	HEC-HMS Model Results
Appendix G	Spillway Channel Capacity Worksheet
Appendix H	Opinion of Probable Project Costs

ABBREVIATIONS

AEP	Annual Exceedance Probability
Anchor QEA/Aspect	Anchor QEA, LLC, and Aspect Consulting, LLC
BGS	below ground surface
CCNRD	Chelan County Natural Resources Department
cfs	cubic feet per second
CMP	Corrugated Metal Pipe
Corps	U.S. Army Corps of Engineers
CWA	Clean Water Act
DAHP	Washington State Department of Archaeology and Historic Preservation
DC	direct current
DEM	Digital elevation model
DF	design factor
DSO	Washington State Department of Ecology Dam Safety Office
Ecology	Washington State Department of Ecology
ESA	Endangered Species Act
GIS	Geographic information system
H:V	Horizontal to vertical
HDPE	High-density polyethylene
HEC-HMS	Hydrologic Modeling System
IDA	Incremental damage analysis
IDF	Inflow Design Flood
IID	Icicle Irrigation District
IPID	Icicle and Peshastin Irrigation Districts
IWG	Icicle Work Group
JARPA	Joint Aquatic Resource Application
L-Cv	Site-specific coefficient used in Dam Safety Office spreadsheet to calculate At-site Mean Precipitation.
L-Skew	Site-specific skew value used in DSO spreadsheet to calculate At-site Mean Precipitation
LNFB	Leavenworth Fish Hatchery
NAVD 88	North American Vertical Datum of 1988
NEPA	National Environmental Policy Act
NHPA	National Historic Preservation Act
NMFS	National Marine Fisheries Service
NPDES	National Pollutant Discharge Elimination System
NRCS	Natural Resources Conservation Service

NRHP	National Register of Historic Places
P_{gds}	Estimated 2-, 6-, or 24-hour precipitation for selected frequency
P_{sd}	Scaling precipitation for 2-, 6- or 24-hour index period
PEIS	Programmatic Environmental Impact Statement
Q	flow rate
Q_{min}	minimum flow rate
SEPA	State Environmental Policy Act
SNOTEL	Snow Telemetry
USGS	U.S. Geologic Survey
USFS	U.S. Forest Service
USFWS	U.S. Fish and Wildlife Service
RCW	Revised Code of Washington
WDFW	Washington Department of Fish and Wildlife
WDNR	Washington Department of Natural Resources
WSEL	Water Surface Elevation

Executive Summary

Eightmile Lake is one of four lakes in the Alpine Lakes Wilderness Area managed by Icicle and Peshastin Irrigation Districts (IPID) to provide water storage for irrigation. A small dam, low-level outlet pipeline, and slide gate at the outlet of Eightmile Lake allow for controlled releases of stored water to supplement flows in Icicle Creek to increase water supply available for irrigation during low flow periods, which typically occur during the late summer. IPID has relied on Eightmile Lake and the other Alpine Lakes they manage for nearly 80 years. Eightmile Lake captures runoff from a 3,822-acre drainage basin. Due to the large size of the drainage basin relative to the storage volume in the lake, Eightmile Lake has a high potential for refill, even during dry years. Because the storage is so reliable and the lake is more accessible than the other Alpine Lakes that IPID manages, the lake is a critical piece of IPID's water supply infrastructure.

The infrastructure at Eightmile Lake is aging and will require improvement to continue to operate in a way that meets IPID's needs. The most urgent issue identified by IPID is that the low-level outlet pipe has collapsed in multiple locations, which has recently reduced the capacity of the pipeline and limits the rate at which IPID can release water to Icicle Creek. If the pipe is not replaced or repaired before the next big drought cycle, IPID will likely not be in a position to meet the irrigation water supply needs of the IPID water users. The gate that controls flow to the low-level outlet pipe also needs to be replaced. It was damaged by ice or debris and is now very difficult to open and close. In addition, the dam structure that allows IPID to store water has deteriorated. Erosion of the earthen embankment portion of the dam structure has reduced the active storage available for release by gravity without pumping or siphoning to less than 1,400 acre-feet. Some additional storage is released via seepage. Due to these limitations, improvements are needed to restore the useable storage capacity of Eightmile Lake to 2,500 acre-feet, which is the volume allowed for storage and release by IPID's water right for the lake. Improvements are also needed to ensure efficient control and release of water stored in the lake to meet downstream water supply and instream flow needs.

In addition, the Jack Creek Fire burned to the shoreline of Eightmile Lake in August of 2017. A large percentage of the Eightmile Lake watershed was damaged by the fire. The potential change in runoff resulting from the fire combined with deficiencies at the dam has caused concern on the part IPID, the Washington State Department of Ecology Dam Safety Office (DSO), and local emergency responders about the potential for a large runoff event to damage the dam or cause it to fail.

This Feasibility Study identified and evaluated the follow improvements for restoring the storage at Eightmile Lake and improving the control and release of water from the lake:

- Replacement of the dam with a reinforced concrete and earthen embankment structure that would have a primary spillway elevation of 4,671 feet, which would match the historical high

water surface elevation (WSEL) in the lake and restore the useable storage capacity to 2,500 acre-feet.

- Construction of an embankment and secondary spillway structure in a low spot south of the existing dam to provide additional spillway capacity to meet Washington State Department of Ecology Dam Safety Office requirements.
- Replacement of the existing low-level outlet facilities with a new pipeline that would allow for greater flexibility in drawing down the lake. Flow through the new low-level outlet would be controlled by an automated valve. Telemetry would allow for remote access from IPID's office to operate the valve and optimize releases. The low-level outlet would operate by gravity when the lake is full and transition to siphon operation as the lake is drawn down.

The hydrology and hydraulics of the proposed lake operation under improved conditions was evaluated to inform the design, as required by Ecology's DSO. Consultation was initiated with DSO as part of this Feasibility Study to better understand their requirements for permitting construction of improvements to the dam and outlet facilities. DSO reviewed the draft Feasibility Study and provided general comments regarding the analysis and geotechnical evaluation of the proposed facilities that will be applied to the detailed design of the improvements. No changes were made to this report to reflect DSO comments regarding the detailed design of the proposed project. Those comments will be addressed through detailed design of the project. This study reflects the concept and feasibility-level analysis completed through the end of 2017 and does not include additional analysis requested by DSO in response to the Jack Creek Fire or recent emergency declaration by IPID. Consultation with DSO is ongoing and will continue through the design and construction of the proposed improvements. The calculations and sizing of facilities provided in this feasibility are based on conservative assumptions for hydrology and the impact that a dam breach would have on downstream properties. Additional analysis completed during detailed design may allow for some optimization of the size and configuration of dam and spillway facilities to reduce the cost and complexity of the project as much as possible.

Eightmile Lake Storage Restoration is one of several projects being evaluated under the direction of the Icicle Work Group. The multi-stakeholder group is working together to identify and evaluate projects that will improve management of water in the Icicle Creek Sub-basin. The group has adopted Guiding Principles that represent the collective goals established by the group for improving water management in the Icicle Creek Sub-basin. The proposed Eightmile Lake Storage Restoration project helps meet multiple prongs of the Guiding Principles, including augmentation of streamflow in Icicle Creek, providing additional water to meet municipal demands, improving agricultural reliability by increasing water supply available in the late summer, creating additional streamflow to meet fish passage and habitat goals, improving treaty and non-treaty harvest rights, and potentially making more water available to Leavenworth National Fish Hatchery.

The primary challenge to implementing this improvement project will be determining how to construct the project at a remote location within the Alpine Lakes Wilderness. IPID has an easement agreement with the USFS that was established when the property was transferred to the USFS for management as part of the Alpine Lakes Wilderness Area. The easement agreement allows IPID to continue to have access to the site, including with mechanized equipment, to maintain the facilities and to make full use of IPID's water right. However, the site is not accessible by roads. The Alpine Lakes are often accessed by IPID by helicopter for maintenance, but even the largest helicopters have payload limitations that will make mobilization of large equipment to the site a challenge. Options that were identified are transport of a smaller excavator by large helicopter, overland transport of a larger tracked excavator, or overland transport of a spider excavator. The approach will likely be dictated by funding, the equipment available, and permit approval constraints.

Another challenge to implementing this project that is closely related to the challenge of mobilizing equipment will be the narrow window available for construction. The lake will need to be drawn down to construct the project, which typically does not happen until late in the summer. IPID might be able to facilitate early drawdown of the lake for construction, but will be constrained by weather and runoff conditions in the early summer. Construction will need to be complete before significant snowfall and consistent freezing temperatures occur. Due to the elevation of the site, snowfall and consistent freezing temperatures are likely to occur in October or early November.

The estimated implementation cost of a project that would rely on helicopters to transport and mobilize equipment to the site is approximately \$2.62 to \$2.97 million. Based on the estimated useable storage that could be restored by the project (1,125 acre feet), the cost would be \$2,329 to \$2,644 per acre-foot of additional storage created.

1 Introduction

Eightmile Lake is one of four lakes in the Alpine Lakes Wilderness Area managed by Icicle and Peshastin Irrigation Districts (IPID) to provide water storage for irrigation. A small dam, low-level outlet pipeline, and slide gate at the outlet of Eightmile Lake allow for controlled releases of stored water to supplement flows in Icicle Creek to increase water supply available for irrigation during low flow periods, which typically occur during the late summer. The proposed Eightmile Lake Storage Restoration Project would replace the existing dam structure, low-level outlet pipeline, gate, and controls to restore the usable storage capacity of the lake and allow for automation and optimization of releases from the lake. This Feasibility Study summarizes the preliminary design analysis of proposed improvements that would restore the available storage capacity in Eightmile Lake to the volume that was historically available to IPID.

1.1 Compatibility with Icicle Strategy

The Eightmile Lake Storage Restoration Project is one of several potential projects currently being evaluated under the direction of the Icicle Work Group (IWG). The IWG is a multi-stakeholder group that was convened by Chelan County Natural Resources Department (CCNRD) and the Washington State Department of Ecology (Ecology) to take a comprehensive look at water resource management in the Icicle Creek Sub-basin. The IWG consists of federal, state, and local agencies; irrigation districts, including IPID; the City of Leavenworth; the Leavenworth National Fish Hatchery (LNFH); non-profit organizations; environmental groups; and other stakeholders. The IWG is working together to identify and evaluate projects that will improve management of water in the Icicle Creek Sub-basin and improve instream flow conditions in lower Icicle Creek. CCNRD retained Anchor QEA, LLC, and Aspect Consulting, LLC (Anchor QEA/Aspect), to complete this Feasibility Study. The study was funded under a grant from Ecology's Office of the Columbia River.

Projects endorsed by the IWG are collectively intended to meet the following nine Guiding Principles:

1. Streamflow that:
 - a. Provides passage
 - b. Provides healthy habitat
 - c. Serves channel formation function
 - d. Meets aesthetic and water quality objectives
 - e. Is resilient to climate change
2. Sustainable hatchery that:
 - a. Provides healthy fish in adequate numbers
 - b. Is resource efficient
 - c. Significantly reduces phosphorus loading
 - d. Has appropriately screened diversion(s)

- e. Does not impede fish passage
3. Tribal Treaty and federally protected fishing/harvest rights are met at all times.
4. Provide additional water to meet municipal and domestic demand.
5. Improve agricultural reliability that:
 - a. Is operational
 - b. Is flexible
 - c. Decreases risk of drought impacts
 - d. Is economically sustainable
6. Improve ecosystem health including protection and enhancement of aquatic and terrestrial habitat.
7. Comply with state and federal law.
8. Protect Non-Treaty Harvest.
9. Comply with the Wilderness Act of 1964, the Alpine Lakes Wilderness Act of 1976, and the Alpine Lakes Wilderness Management Plan.

The intent of the Eightmile Lake Storage Restoration Project is to meet multiple prongs of the Guiding Principles. This project has the potential to achieve the following:

- Augment streamflow in Icicle Creek (Guiding Principle No. 1)
- Provide additional water to meet municipal demands (Guiding Principle No. 4)
- Improve agricultural reliability by increasing water supply available in the late summer to meet IPID's diversion needs (Guiding Principle No. 5)
- Benefit fish passage and habitat (Guiding Principle No. 6) and Treaty and Non-Treaty Harvest (Guiding Principles No. 3 and No. 8)

Relative to Guiding Principle 2, maintaining a sustainable hatchery, it should be noted that the project could also be operated to allow for the release of additional water during the winter low flow period, which would benefit LNFH water supply needs. Low flow conditions in the Icicle Creek Sub-basin typically occur in late-summer and again during the winter when a hard freeze occurs. The Hatchery Canal is dewatered from mid-summer through early spring to meet instream flow needs in Icicle Creek. Releases from Eightmile Lake have not historically occurred during the winter low-flow period, but the improvements discussed in this report could potentially allow for management of releases to benefit LNFH.

1.2 Project Background

Eightmile Lake is located in the Alpine Lakes Wilderness Area of Okanogan-Wenatchee National Forest approximately 10 miles west of the City of Leavenworth, as shown in Figure 1-1. It is one of four lakes in the Alpine Lakes Wilderness Area managed by IPID.

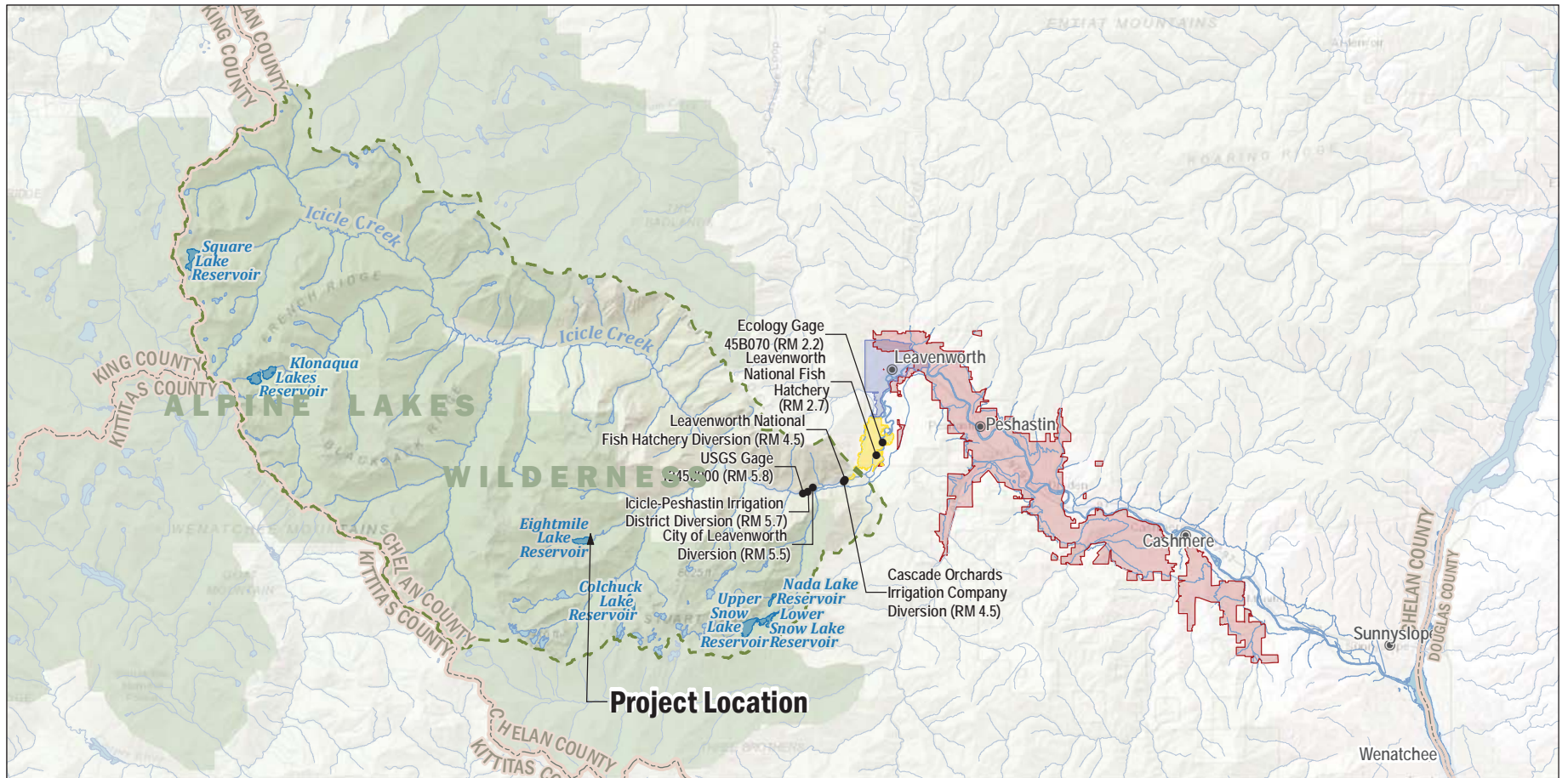

LEGEND:

- Points of Interest
- Leavenworth Urban Growth Area
- Cascade Orchards Irrigation
- IPID Service Area
- ▭ County
- ▭ Icicle Creek Watershed

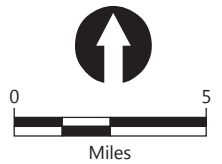

Publish Date: 2017/04/13, 10:02 AM | User: ahill
 Filepath: Q:\Jobs\AspectConsulting_0204\Icicle_Creek_Comp_Water_Management_Plan\Maps\2017_04\Fig1-1_LocationMap.mxd



Figure 1-1
Location Map
 Eightmile Lake Restoration Feasibility Study
 Icicle and Peshastin Irrigation Districts

A small dam with a low-level outlet pipeline or tunnel and control gate was installed at the outlet of each of the lakes in the early part of the twentieth century to allow IPID to capture and store runoff during the winter and spring for release during the late summer low flow period. The supplemental flows allow IPID to maintain irrigation diversions and meet instream flow obligations.

The dam, outlet, and control gate at Eightmile Lake are aging and in need of repair. The dam consists of a rock-masonry/concrete structure with stop logs and an earthen embankment section that extends from the rock-masonry/concrete structure to the hillside north of the dam. Stop logs were historically placed in a notch in the concrete portion of the dam up to the spillway crest (elevation ~4,671 feet North American Vertical Datum of 1988 [NAVD 88]) to allow the lake to fill to that elevation. The earthen embankment portion of the dam has eroded around the left side (looking downstream) of the rock-masonry/concrete structure. Consequently, the dam is not currently capable of impounding water to the full level for which it was designed and at which it historically operated. IPID can now only raise the water to an elevation of approximately 4,667 feet. This has reduced the storage capacity annually available for release by gravity without pumping or siphoning to less than 1,400 acre-feet. Some additional storage is released via seepage. Storage can also be accessed up to IPID's water right (2,500 acre-feet) using pumps or siphons.

The rock masonry/concrete portion of the dam is also deteriorating. The guides and logs used to check the flow of water from the lake through the notch in the concrete portion of the dam no longer function as designed. The slide gate that controls flow from the lake to the low-level outlet pipeline is also very difficult to operate and needs to be refurbished or replaced.

This Feasibility Study summarizes analysis of facilities that would be needed to replace the existing dam, low-level outlet pipeline, and control gate and enable releases from the dam to be automated and optimized to better manage releases. The *Feasibility Study, Alpine Lakes Optimization and Automation* (Aspect 2017) prepared concurrent with this report outlines the feasibility of automating and optimizing the releases from all of the IPID-managed reservoirs to improve late-summer flows in Icicle Creek. The improvements would restore IPID's ability to capture and release up to 2,500 acre-feet, as permitted by their water right for the lake.

1.2.1 Prior Studies and Related Documents

Table 1-1 provides a list of existing key studies and documentation related to the restoration of storage at Eightmile Lake.

**Table 1-1
Prior Studies and Related Documents**

Date	Study and Relevance	Author
April 1981	<p><i>Icicle Irrigation District Helicopter Access Environmental Assessment</i></p> <p>This environmental assessment was completed by the U.S. Forest Service to evaluate Icicle Irrigation District's use of helicopters to access the lakes they manage in the Alpine Lakes Wilderness Area for operations and maintenance. The document recommended use of helicopters for transportation to and from the lakes and found that helicopter access "provides for health and safety as well as protection of wilderness resources and trail systems."</p>	U.S. Forest Service
December 1989 May 1990	<p><i>Easement Termination Agreement and Special Warranty Deed</i></p> <p>These include legal documents deeding the property around Eightmile Lake and other Alpine Lakes held historically by IPID to the U.S. Forest Service, with language that preserves IPID's right to operate and maintain the lakes, access the lakes for maintenance, and make full use of water storage rights for the lakes.</p>	U.S. Forest Service and Icicle Irrigation District
December 1995	<p><i>Reconnaissance Inspection of Eightmile Lake Dam; File No. CH45-228</i></p> <p>This letter was prepared by Ecology's Dam Safety Office following a reconnaissance visit to the site to evaluate and inspect the dam facilities at Eightmile Lake. The letter noted the breach or erosion of the embankment portion of the dam adjacent to the rock masonry structure and concluded that the breach had cut a channel down to a hardened surface that had potential to widen further with subsequent flood events, but that the configuration of the dam did "not pose a sufficient incremental damage threat to warrant mandating a retrofit of the spillway."</p>	Ecology Dam Safety Office; Mel Schaefer Jerald LaVassar Doug Johnson
June 2006	<p><i>Multi-purpose Water Storage Assessment in the Wenatchee River Watershed</i></p> <p>This report, prepared under the direction of IWG member CCNRD, identified and evaluated a wide range of potential opportunities for increasing storage in the watershed, including automating and optimizing releases from the IPID-managed Alpine Lakes (Eightmile, Colchuck, Klonaqua, and Square Lakes)</p>	Montgomery Water Group, Inc. (Now Anchor QEA, LLC)
November 2013	<p><i>Eightmile Lake Surveys Technical Memorandum</i></p> <p>The memorandum summarized topographic and bathymetric survey data collected by Gravity Consulting, LLC, at Eightmile Lake in October of 2013. The survey was collected under the direction of IWG Member Trout Unlimited.</p>	Gravity Consulting, LLC

Date	Study and Relevance	Author
July 2014	<p><i>Draft Icicle Irrigation District Instream Flow Improvement Options Analysis Study</i></p> <p>This study, prepared under the direction of IWG Member Trout Unlimited, included an evaluation of storage volumes and available storage at Eightmile Lake based on the survey that was completed by Gravity Consulting, LLC.</p>	Forsgren Associates, Inc.
March 2015	<p><i>Appraisal Study, Eightmile Lake Storage Restoration</i></p> <p>This study, prepared under the direction of IWG Member CCNRD, provided an appraisal-level assessment of existing storage conditions and lake operations, identified four alternatives for increasing the useable storage in Eightmile Lake, identified options for optimizing and automating releases from the lake, summarized potential uses and benefits of the water that would be made available, and provided a preliminary review of environmental impacts and permitting.</p>	Anchor QEA, LLC, and Aspect Consulting, LLC
March 2015	<p><i>Appraisal Study, Alpine Lakes Optimization and Automation</i></p> <p>This study, prepared under the direction of IWG Member CCNRD, provided an appraisal-level assessment of existing control facilities at each of the managed Alpine Lakes, including Eightmile Lake, and provided recommendations for potential equipment and improvements that would be needed to optimize and automate releases from the lakes.</p>	Aspect Consulting, LLC, and Anchor QEA, LLC

Notes:

CCNRD: Chelan County Natural Resources Department

IPID: Icicle and Peshastin Irrigation Districts

IWG: Icicle Work Group

Several additional studies are being prepared under the direction of the IWG, concurrent with this Feasibility Study, to evaluate the projects being evaluated by the IWG. The two that are most related to this feasibility study include the following:

- *Icicle Strategy Programmatic Environmental Impact Statement* (Aspect pending) – The IWG is currently developing a programmatic environmental impact statement (PEIS) for the strategy that has been developed by the IWG to improve the management of water in the Icicle Creek Sub-basin. The Icicle Strategy PEIS will evaluate four alternatives and a no-action alternative. The alternatives each include a suite of projects that are collectively intended to meet the guiding principles listed above. The Eightmile Lake Storage Restoration Project will be included as a component of three of the four action alternatives evaluated by the PEIS.
- *Feasibility Study; Alpine Lakes Optimization and Automation* (Aspect 2017) – This study, prepared under the direction of IWG member CCNRD, will include a feasibility-level evaluation and design recommendations for implementing improvements that will allow IPID and the U.S. Fish and Wildlife Service to optimize and automate releases from the managed lakes in the Alpine Lakes Wilderness Area, including Eightmile Lake.

1.3 Feasibility Study Description

This study provides a feasibility-level evaluation and design recommendations for a project that would replace the existing dam, low-level outlet pipeline, and control gate facilities at Eightmile Lake with facilities that are designed to restore the useable storage at Eightmile Lake to 2,500 acre-feet and allow for automated releases from the lake.

Consultation was initiated with DSO as part of this Feasibility Study to better understand their requirements for permitting construction of improvements to the dam and outlet facilities. DSO reviewed the draft Feasibility Study and provided general comments regarding the analysis and geotechnical evaluation of the proposed facilities that will be applied to the detailed design of the improvements. No changes were made to this report to reflect DSO comments regarding the detailed design of the proposed project. Those comments will be addressed through detailed design of the project. This study reflects the concept and feasibility-level analysis completed through the end of 2017 and does not include additional analysis requested by DSO in response to the Jack Creek Fire or recent emergency declaration by IPID. Consultation with DSO is ongoing and will continue through the design and construction of the proposed improvements.

1.3.1 Scope of Work

The scope of work for this Feasibility Study included the following work:

- The Anchor QEA/Aspect team worked with IPID and Chelan County to identify key components and characteristics of the preferred design concept, based on additional data and observations made during the Summer of 2015, when water was drawn down below the existing outlet, and the outlet pipe condition was determined to be significantly different than assumed in the *Appraisal Study, Eightmile Lake Storage Restoration* (Anchor QEA 2015)
- The Anchor QEA/Aspect team worked with IPID and Chelan County to evaluate potential approaches to constructing the proposed improvements to Eightmile Lake.
- The Anchor QEA/Aspect team provided preliminary sketches showing key components of the preferred design concept to confirm the preferred concept with IPID and Chelan County.
- The Anchor QEA/Aspect team developed a draft construction work plan for IPID use in coordinating with the United States Forest Service (USFS).
- The Anchor QEA/Aspect team reviewed the potential improvements with Ecology's Dam Safety Office (DSO) to identify likely requirements for securing a DSO dam construction permit. This report summarizes the design reports, application forms, and supporting documentation that would be required for DSO review and approval of dam modifications.
- The Anchor QEA/Aspect team refined the evaluation of hydrology, lake levels, and refill, based on work completed during the summer of 2016.
- The team analyzed peak inflow hydrology and hydraulics of the low-level outlet, spillway, and dam improvements as a basis for sizing the facilities to meet DSO requirements.

- The Anchor QEA/Aspect team also developed conceptual design drawings showing proposed improvements in plan and section view, identifying key materials and dimensions.
- The Anchor QEA/Aspect team prepared an opinion of probable costs.
- The Anchor QEA/Aspect team developed a photographic rendering illustrating what the proposed reservoir modifications might look like following construction.
- The Anchor QEA/Aspect team prepared this report to summarize the findings of the Feasibility Study.

1.3.2 *Purpose and Objectives*

The following are the goals of the Feasibility Study:

- Review and provide a more complete understanding of the existing conditions, constraints, and design requirements for proposed improvements at Eightmile Lake.
- Evaluate the preferred improvement option in enough detail to provide IPID and the IWG with the information needed to determine whether additional resources can be allocated to complete the design and implement the project and identify those resources.

The overall goal of the Eightmile Lake Restoration project is to restore storage capacity at Eightmile Lake and improve control of releases from the lake to improve the water supply available in Iccle Creek to meet instream flow and out-of-stream water supply needs.

1.4 Report Organization

This report is organized into the following sections:

- **Existing Reservoir Conditions** provides a summary of existing conditions and deficiencies at Eightmile Lake based on recent work done by Anchor QEA, Aspect, Gravity Consulting, LLC, and Forsgren Associates, Inc.; input from IPID; and conditions documented during a site visit to the lake.
- **Eightmile Lake Hydrology** summarizes the results of hydrologic analyses including watershed yield, a downstream hazard analysis, and design storm calculations and analysis.
- **Eightmile Lake Storage Restoration Design** summarizes proposed hydraulic analysis, design calculations, and improvements.
- **Construction Approach** provides a summary of construction access and sequencing options and anticipated limitations to implementing the proposed project.
- **Cost Analysis** includes a summary of preliminary opinions of probable project costs associated with the proposed restoration design.
- **Water Rights** summarizes the existing water rights associated with storage and release of water from Eightmile Lake.
- **Environmental and Permitting Strategy** includes a summary of likely environmental impacts and permitting requirements, and recommends a strategy for securing permit approvals.

- **Summary and Recommendations** provides an overall summary of the Feasibility Study and recommendations for future study and implementation.

Tables and figures are included throughout the report. Appendices, including design drawings, photographs, calculations, and other information, are included at the back of the report.

1.5 Feasibility-level Design Drawings

Feasibility level design drawings have been prepared and are included in Appendix A. In addition, a rendering was developed to illustrate what the finished project might look like from an aerial perspective. The rendering is show in Figure 1-2.



2 Existing Reservoir Conditions

Eightmile Lake is located in the Icicle Creek Sub-basin on the east slopes of the Cascade Mountains approximately 10 miles west of the City of Leavenworth, Washington (See Figure 1-1). The lake is situated within Sections 32 and 33, T24N, R16E, and currently has a full water surface area of approximately 76.6 acres. Eightmile Lake captures water from a 3,822-acre drainage basin and discharges surface water to Eightmile Creek, which is a tributary to Icicle Creek. The Eightmile Lake drainage basin is delineated in Figure 2-1.

The lake can be accessed on foot via the Eightmile Lake Trail (USFS Trail No. 1552). The trailhead is accessible from Leavenworth by vehicle following Icicle Road, USFS Road 7600, and USFS Road 7601. The trail generally follows Eightmile Creek from U.S. Geologic Survey (USGS) Road 7601 to Eightmile Lake. The distance from the trailhead to the lake is approximately 4 miles. Because of its relative accessibility, the lake is a popular destination for hikers and campers. Because of its proximity to Icicle Creek and relative ease of access, IPID visits Eightmile Lake and operates the gate to release water from the lake more frequently than at the more remote lakes it operates. Consequently, it is a critical piece of IPID's water supply infrastructure.

The existing facilities that control flow from Eightmile Lake to Eightmile Creek consist of a dam and embankment structure, a low-level outlet pipeline, and a slide gate. The configuration of these facilities is shown on the existing conditions plan of the feasibility-level design drawings (See Drawing G-04, Appendix A). Additional survey data was collected on the dam structure and low-level outlet pipeline during a site visit on September 30, 2016, to provide better definition for development of the feasibility-level design.

2.1 Dam and Embankment

The existing dam consists of a rock masonry and concrete wall structure with an earthen embankment section. Photographs 1 and 2 (Appendix B) show the dam and spillway structures. Pieces of the masonry rock and concrete wall structure have deteriorated and fallen down, but most of the structure is still intact. The rock masonry and concrete structure spans approximately 43 feet across the outlet of the lake and features the following:

- **Flow Control Notch** – A 5-foot 9-inch-wide notch near the center of structure, has a crest elevation of 4,661.6 to 4,661.8 feet. Guides were originally included in the notch so that stop logs could be placed to control the level at which the lake spills to the downstream channel through the notch. The stop log guides have deteriorated and no longer function as designed; however, IPID still places logs in the notch and drapes plastic over the logs to control the high water surface elevation in the lake.

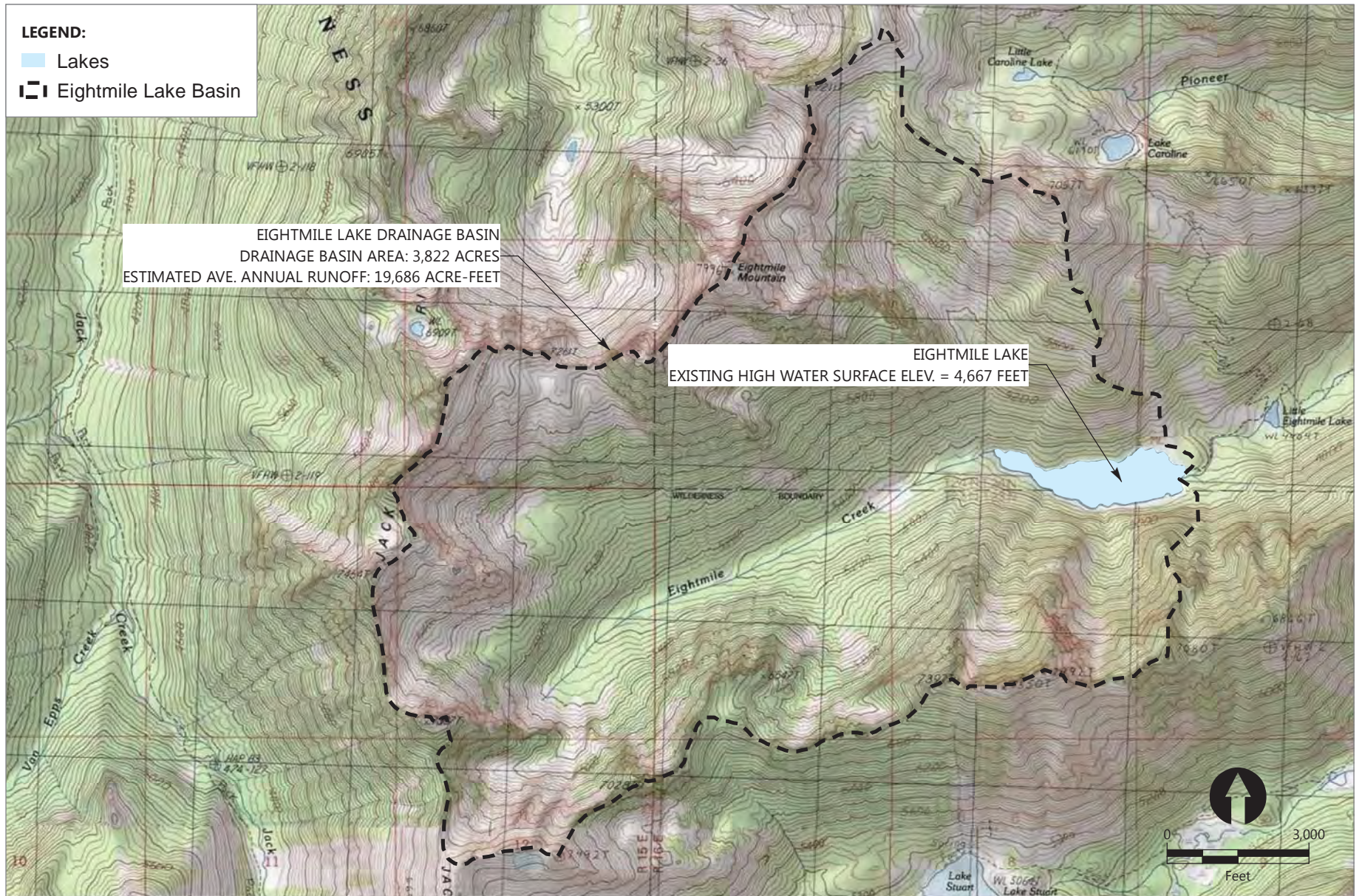

Publish Date: 2017/04/13, 9:00 AM | User: ahill
 Filepath: Q:\Jobs\AspectConsulting_0204\Icicle_Creek_Comp_Water_Management_Plan\Maps\2017_04\Fig2-1_EightmileDrainage.mxd



Figure 2-1
Eightmile Lake Drainage Basin
 Eightmile Lake Storage Restoration Feasibility Study
 Icicle and Peshastin Irrigation Districts

- **Spillway** – The wall south of the notch comprises the historical spillway, with a crest elevation that varies from 4,671.3 to 4,671.4. The spillway crest length is approximately 6 feet. Historically, stop logs were placed in the notch during the spring or early summer to capture runoff and raise the lake level to the spillway elevation (~4,671 feet).
- **South Wing Wall** – A rock masonry wall extends from the spillway to the hillside south of the structure. The high point on the south wing wall is just over 4,673 feet.
- **North Wing Wall** – A rock masonry wall also extends from the notch north of the dam. The highest portion of the north wing wall is also just over 4,673 feet. The earthen embankment portion of the dam was historically connected to the north wing wall and likely matched the elevation at the top of the wing wall.
- **Stilling Basin and Cutoff Wall** – When the gate on the low-level outlet is closed and the lake is full to the top of the stop logs in the flow control notch, water spills over the stop logs into a concrete basin on the downstream side of the structure. It is not clear what the design function of the basin was intended to be, but it appears to have been the original location of the control gate and may have provided access to the low-level outlet pipeline. The basin extends down to within a few feet of the top of the low-level outlet pipe, but it is typically filled with rock, logs, and debris. The basin was cleaned out in 2015 by IPID in an effort to determine the connection between the basin and the low-level outlet pipeline. A concrete cutoff wall forms the downstream edge of the basin and extends down to the low-level outlet pipeline. IPID has observed that water flowing into the basin disappears through the debris into the low-level outlet pipeline. During high flow periods, the basin fills completely with water and excess water discharges over the cutoff wall and to the rock-lined Eightmile Creek channel. The IPID Manager indicated that under current operation, water overtops the cutoff wall on the downstream side of the basin during the spring and early summer.

The earthen embankment section of the dam extends more than 120 feet from the hillside north of the dam to the north wing wall. The portion of the earthen embankment closest to the north wing wall has eroded to an elevation that is more than 4 feet below the crest of the spillway. No historical information has been found to indicate exactly how or when the embankment was eroded. It likely occurred during a large storm event when no one was at the site to observe. The erosion suggests that the spillway is not large enough to accommodate flow rates during peak storm events. The width of the eroded portion of the embankment is approximately 25 feet. The upper (west) portion of the embankment appears to be intact and is covered with large rock.

Three engineers from Ecology DSO completed a reconnaissance inspection of the dam in September 1995. A letter prepared following the inspection (Ecology 1995) summarized their observations and conclusions. They observed both the earthen embankment and the rock masonry/concrete structure. They noted that the portion of the embankment adjacent to the rock masonry/concrete structure had eroded and the cut was roughly 25 feet wide and 5 feet deep. They

concluded that this “past breach of the embankment has cut a channel across the embankment down to a “hardened” or stable floor. In the event of another major flood, it is likely that the breach section would widen further.” Although this widening during a major flood would likely result in surges of flood releases, DSO suggested that the spillway might actually “function, to a limited degree, as a false plug spillway – cutting laterally rather than vertically.” They concluded that the “possibility of surges and on-going flood releases from a lateral erosion of the existing breach may be construed by the Owner to be a liability concern. If so, they may wish to minimize their liability by widening and hardening the channel now.” However, in the judgement of the DSO Engineers that did the inspection, the dam configuration at the time of the inspection did not pose a “sufficient incremental damage threat to warrant mandating a retrofit of the spillway”.

2.2 Low-Level Outlet Pipeline and Gate

A slide gate and low-level outlet pipeline control releases from Eightmile Lake to Eightmile Creek. The gate is a 30-inch-diameter, round, cast iron slide gate and was originally equipped with a hand-wheel operator. The gate is typically submerged in the lake just upstream of the dam, but can be opened to release water through the low-level outlet pipeline to Eightmile Creek. It appears that a rock-masonry/concrete gate tower was originally constructed to support the gate stem and manual hand-wheel operator, which was mounted above the water surface of the lake. The tower appears to have been completely destroyed and the manual gate operator has been removed. The IPID Manager indicated that the gate and tower were likely damaged by ice or debris. The gate currently has to be operated by attaching a log as a come-along to a square metal loop welded to the top of the remaining gate stem below the water surface. This makes gate operation very challenging. The IPID Manager also indicated that rock settles above and against the gate, preventing the gate from closing completely. IPID removed the rock that was piled against the gate and cleaned out the channel leading to the gate from the lake when the lake was drawn down at the end of the summer of 2015. Photograph 3 (Appendix B) shows the exposed gate.

The existing low-level outlet pipeline is nearly 300 feet long and consists of pipe that varies in size and composition. IPID personnel inspected the pipe from the inside late in the summer of 2015 when the lake was drawn down to document the condition and configuration. The existing conditions map in the feasibility-level drawing set shows the observed pipe configuration (See Drawing G-04, Appendix A). The following segments of pipe were observed by IPID:

- **30-inch Corrugated Metal Pipe (CMP), Gate to Dam Structure** – This segment of pipe is in relatively good condition and includes two bends.
- **30-inch Wood Stave Pipe, Under Dam Structure** – Under the stilling basin on the downstream side of the dam structure, the pipe transitions to wood stave pipe.
- **Open Chamber with Log Ceiling** – At the cutoff wall on the downstream side of the stilling basin, the pipe transitions into a more open chamber with a log ceiling. The chamber varies in

height and width. An opening has eroded at the base of the cutoff wall that allows water in the stilling basin to flow into the chamber from above and down the low-level outlet pipe.

- **30-inch Log Stave Pipe** – A log stave pipe, formed by banding raw, round logs together with steel bands, extends from the open chamber on the downstream side of the first cutoff wall to an open chamber on the upstream side of the second cutoff wall. The log stave pipe has collapsed mid-way between the cutoff walls. IPID has indicated that capacity of the pipeline has declined significantly due to blockage caused by this collapse and is a major concern for IPID.
- **Open Chamber with Log Ceiling** – A second chamber is located at the second cutoff wall, approximately 48 feet downstream of the first cutoff wall.
- **30-inch CMP, Downstream of Cutoff Wall** – A segment of 30-inch CMP extends downstream of the second cutoff wall and includes a bend.
- **30-inch Wood Stave Pipe** – The 30-inch CMP transitions to Wood Stave Pipe again downstream of the bend.
- **30-inch CMP, Wood Stave Pipe to Outlet** – A final segment of 30-inch CMP extends from the Wood Stave Pipe to the outlet to the Eightmile Creek channel. The CMP pipe has a couple of large deformations.

Photographs of the pipe interior are included as Photographs 8 through 11 in Appendix B. Most of the pipe is buried under large rock. The pipe outlet is typically submerged in the spring and early summer. A large rock that had been naturally deposited in the channel immediately downstream of the outlet was removed by IPID as part of the maintenance and inspection done late in the summer of 2015. The IPID Manager indicated that when the gate is open and the reservoir is releasing water, conditions at the pipe outlet are turbulent.

2.3 Overflow Channel to Eightmile Creek

An overflow or spillway channel extends from the dam above the buried low-level outlet pipeline to the pipe outlet. The channel is filled with large rock. At least some of the rock appears to have been deposited in the channel naturally since it was first constructed. The channel is typically filled with water during the spring and early summer when the lake is spilling. During the late summer, when the gate is open and controlled releases are occurring, the channel runs dry down to the low-level pipeline outlet.

2.4 Useable Storage Capacity

A survey and lake volume evaluation was completed by Gravity Consulting, LLC, and Forsgren Associates, Inc. (Forsgren 2014), to estimate the volume of the lake at key water surface elevations. The volumes estimated in that report are summarized in Table 2-1. Elevations were surveyed by Gravity Consulting, LLC, relative to the NAVD 88. All elevations reported in this Feasibility Study are

based on that datum. Gravity Consulting, LLC, estimated that the current high water surface elevation was approximately 4,667 feet, based on the current configuration of the dam and input from IPID about placement of stop logs. If IPID attempts to raise the water level higher than that by adding more stop logs to the notch, water spills through the embankment breach around the north wing wall of the dam. The total estimated volume of the lake at that elevation is estimated to be approximately 2,706 acre-feet. The current useable storage in the lake is the volume of water storage between the minimum drawdown level, which was estimated by Gravity Consulting, LLC, and Forsgren Associates, Inc., to be approximately 4,644 feet, and the current high water surface elevation, 4,667 feet. The current usable storage volume, or storage available for release by gravity without pumping or siphoning, was estimated to be approximately 1,375 acre-feet.

**Table 2-1
Lake Volume Summary (From 2014 Forsgren Associates, Inc./Gravity Consulting, LLC Study)**

Description	Water Surface Elevation (Feet)	Water Surface Area (Acres)	Total Volume (Acre-feet)	Usable Storage Volume ¹ (Acre-feet)
1) Existing Low-Level Outlet (Max Drawdown)	4,644	44.1	1,331	↑ 1,375 ↓
2) Existing Top of Weir at Flow Control Notch	4,664	73.5	2,486	
3) Existing High Water Surface	4,667	76.6	2,706	
4) Existing Spillway Crest/Historical High Water Surface	4,671	80.8	2,998	

Note:

1. Icicle and Peshastin Irrigation Districts estimates that additional seepage below the low-level outlet draws the lake down below elevation 4,644 and that the total useable storage, or total volume that can be released from the lake during the late summer, with the additional seepage that occurs after the lake has been drawn down to the low-level outlet, is approximately 1,600 acre-feet.

Additional topographic survey data was collected as part of this analysis to provide better definition of the embankment, rock masonry/concrete structure, and low-level outlet. Table 2-2 summarizes the key elevations and existing stage-storage-area relationship in the lake, based on a refined analysis with the new data collected. When the original analysis was done by Gravity Consulting, LLC, and Forsgren Associates, Inc., the inlet to the low-level outlet pipeline was submerged and likely buried by rock and debris. The additional survey data gathered in 2016 was collected when the lake was drawn down to the low-level outlet elevation. The surveyed elevation at the invert of the low-level outlet is more than 4 feet higher than what was originally estimated as the maximum drawdown elevation. The useable storage volume between the estimated high water surface elevation and the surveyed invert of the low-level outlet is actually only 1,151 acre-feet. However, the lake continues to draw down below the low-level outlet during the late summer due to seepage. For example, the water surface level of the lake during September 2015 was observed at least 3 feet below the low-

level outlet invert. So, it is likely that the lake can be drawn down to an elevation beyond the 4,644 feet estimated by Gravity Consulting, LLC, and Forsgren Associates, Inc., through seepage at the end of the summer. IPID estimates that the total volume that can currently be released by gravity in the late summer without pumping or siphoning, when considering the volume that drains via seepage below the low-level outlet, is approximately 1,600 acre-feet.

**Table 2-2
Lake Volume Summary (Based on Additional Data Collection)**

Description	Water Surface Elevation (Feet)	Water Surface Area (Acres)	Total Volume (Acre-feet)	Usable Storage Volume ² (Acre-feet)	
0) Existing Low Lake Level (Max Drawdown) ^{1, 2}	4,644.0±	44.1	1,331	↑ 1,367 ↓	↑ 1,151 ↓
1) Existing Low-level Outlet Invert	4,648.7	47.9	1,547		
2) Existing Top of Weir at Flow Control Notch	4,664.6	73.7	2,514		
3) Existing High Water Surface ²	4,667.0±	76.6	2,698		
4) Existing Spillway Crest/Historical High Water Surface	4,671.3	81.7	3,035		

Notes:

- Existing low lake level was not surveyed in fall 2016, but is based on original analysis by Gravity Consulting, LLC, and Forsgren Associates, Inc. The low lake level has been observed a few feet below the invert of the existing low-level outlet invert. The lake continues to draw down water below the low-level outlet through seepage during the late summer.
- IPID estimates that additional seepage below the low-level outlet draws the lake down below elevation 4,644 and that the total useable storage, or total volume that can be released from the lake during the late summer, with the additional seepage that occurs after the lake has been drawn down to the low-level outlet, is approximately 1,600 acre-feet.
- Existing high water surface not surveyed in fall 2016, but is based on original analysis by Gravity Consulting, LLC, and Forsgren Associates, Inc.

2.5 Topography

Eightmile Lake captures runoff from a 3,822-acre drainage basin on the east slopes of the Cascade Range. The general topography of the basin is very rugged and comprises steep craggy peaks and a deep glacial valley. Elevations in the basin range from approximately 7,980 feet to the outlet of Eightmile Lake, at approximately 4,661 feet. The mean basin slope, calculated from a 30-meter USGS digital elevation model (DEM), is 62%.

2.6 Geology

A geotechnical investigation has not been completed as a basis for the design of the improvements to Eightmile Lake; however, general data on soil types and geology was collected from USGS and Natural Resources Conservation Service (NRCS). The geology of the Eightmile Lake basin is dominated by rocky soils and tonalite geology. According to the NRCS Web Soil Survey database, approximately 79% of the soils within the basin are designated as rock outcrop or rock outcrop

complex, with bedrock at or within 3 feet of the surface. The valley bottom is composed primarily of very rocky, sandy loam with boulders and comprises approximately 19% of the basin terminating at the outlet of the lake. The underlying geology is dominated by tonalite, which is classified as an igneous, intrusive rock of felsic composition, with phaneritic texture. Less abundant geologic components include ultrabasic (ultramafic) rock, talus deposits, alluvium, and mass-wasting deposits.

A geology map, showing geologic units mapped by the USGS, is included in Figure 2-2. The map shows that there is a large landslide area with mass-wasting deposits just north and east of the lake. This landslide area and the associated rock and boulders deposited at the base of it are visible on aerial photographs of the lake (See Drawing G-03, Appendix A).

2.7 Existing Reservoir Operations

Eightmile Lake is one of four storage sites in the Alpine Lakes Wilderness managed by IPID. The operation of Eightmile Lake was last reviewed with the IPID Manager during a site visit in September 2016. During a typical year, the storage from only one or two of the IPID-managed lakes is actively managed. Typically, releases from the lakes are rotated from year to year to ensure that the lakes refill between releases. However, because of its proximity to Icicle Creek, relative ease of access, and high probability of refill, the useable storage at Eightmile Lake is released more frequently than the storage at the more remote lakes.

The lake typically fills to the crest elevation of the notch in the rock masonry/concrete portion of the dam during the winter and spring. IPID personnel go to the lake when the snow melts enough to provide access late in the spring or early in the summer to place stop logs and plastic to capture the last few feet of additional storage while the snowmelt runoff is still occurring. To actively manage the storage in Eightmile Lake, IPID personnel hike to the lake to open the gate on the low-level outlet pipeline sometime in July or August when flows in Icicle Creek begin to drop. IPID personnel return to close the gate, remove the stop logs and plastic, and perform maintenance in late September or October, when the lake is drawn down and the irrigation season is over.

When the gate is open, water discharges through the low-level outlet to Eightmile Creek, which is a tributary to Icicle Creek. Based on recent experience and observations from IPID personnel, the lake typically refills by early summer following the irrigation season when the lake is drawn down. The useable storage capacity available for release and the equivalent volume that has to be refilled is limited by the condition of the dam at the outlet. When the lake is full, water flows over the stop logs in a notch in the dam and down the low-level outlet or spillway channel to Eightmile Creek. Water continues to flow through the lake uncontrolled, until the gate is opened for controlled release.

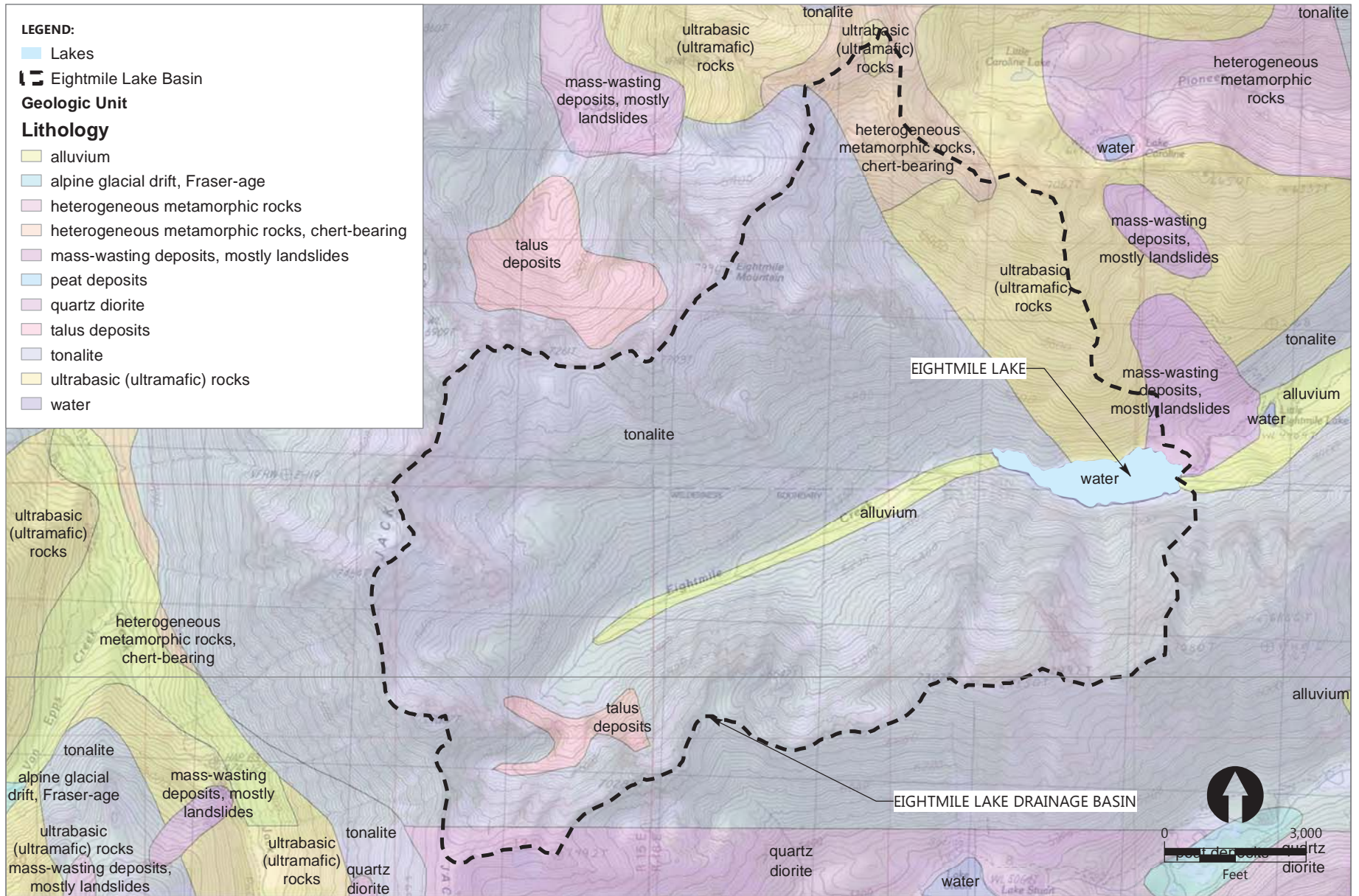

Publish Date: 2017/04/13, 9:05 AM | User: ahill
 Filepath: Q:\Jobs\AspectConsulting_0204\Icicle_Creek_Comp_Water_Management_Plan\Maps\2017_04\Fig2-2_EightmileGeology.mxd



Figure 2-2
Eightmile Lake Drainage Basin Geology Map
 Eightmile Lake Storage Restoration Feasibility Study
 Icicle and Peshastin Irrigation Districts

2.8 Challenges, Deficiencies, and Constraints

Several operational challenges and deficiencies exist due to the current configuration and condition of the facilities at Eightmile Lake. These include the following:

- **Gate Operation** – Current gate operation requires that IPID personnel attach a log as a come-along to a submerged metal loop welded to the gate stem to open and close the gate. IPID also indicated that rock settles above and against the gate. These two issues make the gate very difficult to open and close. Rock was removed from above and against the gate in the summer of 2015 when the lake was drawn down.
- **Dam Condition and Level Control** – The dam is no longer in condition to allow for effective control of the water level at the notch in the dam. The embankment portion of the dam has eroded adjacent to the rock masonry/concrete portion of the dam to an elevation that is lower than the dam crest and historical overflow elevation.
- **Lake Drawdown** – IPID's water rights allow for lake storage to be drawn down below the invert of the existing low-level outlet. Some drawdown below the low-level outlet occurs through seepage. However, drawing the lake down to access additional storage below the low-level outlet currently requires pumping.
- **Low-Level Outlet Pipe Condition** – The condition of the low-level outlet pipe was visually assessed by IPID in 2015. As noted previously, some sections of the pipe are damaged or collapsing. The largest collapse has recently reduced the capacity of the pipeline is a major concern for IPID. If water cannot be released at the historical rate of release, there could be water shortages in Icicle Creek during the late summer in coming drought years.

3 Eightmile Lake Hydrology

Critical information needed for the design of improvements at Eightmile Lake include hydrologic inputs to the lake, peak storm conditions, and estimates of the design capacity of the dam, spillway facilities, and low-level outlet facilities to safely pass or release flows while minimizing the risk to downstream properties and infrastructure. This section summarizes the hydrologic analysis done to determine the design storm and peak flow rates used for design of improvements to the dam, spillway, and low-level outlet pipeline.

3.1 Dam Safety Review

The proposed improvements to Eightmile Lake will require review and approval by Ecology's DSO. Consultation was initiated with DSO as part of this Feasibility Study to better understand their requirements for permitting construction of improvements to the dam and outlet facilities. DSO reviewed the draft Feasibility Study and provided general comments regarding the analysis and geotechnical evaluation of the proposed facilities that will be applied to the detailed design of the improvements. No changes were made to this report to reflect DSO comments regarding the detailed design of the proposed project. This study reflects the concept and feasibility-level analysis completed through the end of 2017 and does not include additional analysis requested by DSO in response to the Jack Creek Fire or recent emergency declaration by IPID. Consultation with DSO is ongoing and will continue through the design and construction of the proposed improvements. Based on consultation with DSO to date, DSO will likely require that the following items be submitted for review and approval prior to issuing a dam construction permit for the improvements:

- **Cover Letter** – The cover letter would summarize the project and introduce the deliverables.
- **Dam Construction Permit Application** – A completed dam construction permit application would be downloaded from the DSO web site and submitted with the supporting documents.
- **Engineering Reports**
 - **Geotechnical Engineering Report** – DSO will require that a geotechnical engineer perform a complete subsurface geotechnical field investigation and prepare a report with recommendations for the dam foundation, embankment composition and construction, a description of the local groundwater regime, and identification of earthquake and other potential hazards. Because the site is remote and cannot easily be accessed with equipment to do an effective subsurface geotechnical investigation, completion of geotechnical field investigations will be very challenging. Test pits and geophysical methods will likely be required, at a minimum, to support the design. The design will also require geotechnical supervision, input, and review during construction to address site conditions.
 - **Hydrology and Hydraulics Report** – DSO will require a detailed report with a description of the site, a summary of site hydrology, an estimate of all sources of inflow

to Eightmile Lake, and hydrologic analysis to estimate the Inflow Design Flood (IDF). The report would also detail the design of the reservoir and provide estimates of the reservoir capacity, low-level outlet capacity, spillway capacity, and other design calculations. Sections 3 and 4 of this report include most of the information that would go into the Hydrology and Hydraulics Report for DSO.

- **Detailed Design Drawings** – Feasibility level design drawings are included in Appendix A. The design drawings would be developed to the level of detail needed for construction.
- **Technical Specifications** – A set of detailed technical specifications would be developed with the detailed design drawings.
- **Construction Inspection Plan** – DSO would require a short report listing specific construction activities, quality assurance testing, construction management, change order process, record keeping, and reporting during construction.
- **Operations and Maintenance Plan** – This document would provide general information on project operation, routine inspection and maintenance, and instrumentation and monitoring. Forms would be included for reporting, inspections, incident reporting, and monitoring.
- **Emergency Action Plan** – This document would identify downstream risk from a dam breach and delineate the area that could be inundated based on modeling of a dam breach. This document would also identify the Owner’s response actions and responsible personnel.

The requirements and level of detail needed for each of these items will vary based on the scope and extent of improvements to the facilities at Eightmile Lake. For example, a full replacement of the existing dam, spillway, and low-level outlet facilities will require more detailed documentation than if only minor modifications were made to the existing facilities. However, DSO has indicated that they would need to perform some level of review and provide approval for any modifications to these facilities. This report has been reviewed with DSO and consultation is ongoing to define requirements for the detailed design of the proposed facilities.

3.2 Watershed Description

As noted earlier, Eightmile Lake is located in the Icicle Creek Sub-basin on the east slopes of the Cascade Mountains approximately 10 miles west of the City of Leavenworth, Washington. The lake currently has a full water surface area of approximately 76.6 acres. Eightmile Lake captures water from 3,822-acre drainage basin (approximately 6 square miles), as shown in Figure 2-1, and discharges water to Eightmile Creek, which is a tributary to Icicle Creek. The Eightmile Lake drainage basin is predominantly covered with rocky outcrops and exposed bedrock, with steep slopes and rugged terrain. Sub-alpine evergreen forest covers approximately 30% of the drainage basin.

3.3 Watershed Yield

Watershed yield is the annual volume of natural runoff that can be expected from a watershed and is typically estimated based on streamflow measured at a given location. There are not streamflow gaging stations or measurement devices in the Eightmile Lake drainage basin. In the absence of streamflow data, hydrologic analysis can be completed to estimate watershed yield. Watershed yield and lake recharge potential were originally evaluated as part of the *Appraisal Study, Alpine Lakes Optimization and Automation* (Aspect/Anchor QEA 2015). These calculations were updated and refined for the Eightmile Lake drainage basin as part of this study. The following describes the methodology used:

- The drainage basin for Eightmile Lake was delineated using geographic information system (GIS) software and DEM data from the USGS, as shown in Figure 2-1.
- Daily precipitation and snow-water equivalent data were downloaded from seven Snow Telemetry (SNOTEL) stations near Eightmile Lake. The monthly runoff, in inches, was estimated at each SNOTEL station based on daily precipitation and snow-water equivalent data.
- The average monthly precipitation in the Eightmile Lake drainage basin was estimated in GIS from the 1981 through 2016 average precipitation dataset from the Oregon State University PRISM Climate Group.
- The locations, elevations, and precipitation data from Water Years 1985 to 2016 of the SNOTEL sites was compared with the location, elevation, and estimated precipitation for the Eightmile Lake drainage basin. Based on the comparison, the Stevens Pass SNOTEL site was identified as the most appropriate for determining runoff for Eightmile Lake.
- A precipitation ratio was developed for Eightmile Lake that represents the ratio of the average annual precipitation in the lake's drainage basin, as estimated from the PRISM precipitation data, to the average annual precipitation at Stevens Pass from the SNOTEL data.
- Monthly runoff, in inches, was estimated for the Eightmile Lake drainage basin by multiplying the estimated runoff at the Stevens Pass SNOTEL site by the precipitation ratio developed for the lake for Water Years 1985 through 2016.
- The total monthly runoff volume, in acre-feet, was estimated for Eightmile Lake by multiplying the estimated runoff, in inches, by the area of the lake's drainage basin for Water Years 1985 through 2016.
- Evaporation was estimated for Eightmile Lake by using estimated evaporation from nearby stations. The two stations closest to Eightmile Lake are Wenatchee and Bumping Lake. It was determined that the Bumping Lake evaporation station would be the most appropriate for determining evaporation for Eightmile Lake because the elevations are similar. Monthly evaporation rates were determined by multiplying the monthly pan evaporation rate for Bumping Lake by 75% to convert pan evaporation to lake evaporation. The lake evaporation

was then multiplied by the full lake area to get an estimated monthly evaporation volume for Eightmile Lake for water years 1985 through 2016.

- Watershed yield was estimated for Eightmile Lake by subtracting the monthly evaporation volume from the monthly runoff volume.

Statistics of available annual watershed yield, or net annual inflow, were developed for Eightmile Lake, as shown in Table 3-1. The annual volume of useable storage allowed by IPID’s water right (2,500 acre-feet) is a relatively small percentage of the watershed yield, even under drought conditions. Even if the maximum volume was released under drought conditions, the recharge potential for the lake is expected to be very high. The high recharge potential and relative ease of access make this lake an extremely valuable storage facility for maintaining flows in Iccle Creek and water supply available to IPID, especially during drought years.

**Table 3-1
Eightmile Lake Drainage Area and Estimated Watershed Yield**

Characteristic	Estimated Value
Drainage Area	3,822 acres
Maximum Annual Watershed Yield	31,001 acre-feet
10% Exceedance Annual Watershed Yield	24,829 acre-feet
Mean Annual Watershed Yield	19,686 acre-feet
50% Exceedance Annual Watershed Yield	19,128 acre-feet
90% Exceedance Annual Watershed Yield	15,152 acre-feet
Minimum Annual Watershed Yield	11,419 acre-feet

Notes:

1. Watershed yield estimated based on precipitation and evaporation data from 1985 through 2016.

3.4 Downstream Hazard Analysis

Ecology’s *Dam Safety Guidelines Technical Note 1: Dam Break Inundation Analysis and Downstream Hazard Classification* (MGS Engineering Consultants, Inc. 2007) provides methodology for assessing downstream hazards based on a potential dam failure and resulting inundation. A preliminary hazard analysis was performed using Ecology’s “Selection of Design/Performance Goals for Critical Project Elements” worksheet (Appendix C). The results of the hazard analysis yielded a “High” (Class 1A-1C) downstream hazard classification that indicates risk of loss of life, major economic loss, and lasting environmental damage from a potential dam break.

Ecology’s *Dam Safety Guidelines Technical Note 2: Selection of Design/Performance Goals for Critical Design Elements* (Technical Note 2; Ecology 1992) provides guidelines for selecting design/performance goals for dam facilities using an eight-step format, where the

design/performance goals become more stringent with each step. A "High" (Class 1A-1C) downstream hazard classification typically requires use of Step 7 or Step 8 design/performance goals. Section 2 of Technical Note 2 indicates that, "Design Step 8 is applicable where the consequences of dam failure could be catastrophic with hundreds of lives at risk." The design/performance goal at Step 8 has an Annual Exceedance Probability (AEP) of 10^{-6} , or one chance in one million, of being exceeded in any given year, and generally corresponds to the theoretical maximum design event.

Ecology's *Dam Safety Guidelines Part IV: Dam Design and Construction* (Ecology 1993) allows for an alternative method of selecting the magnitude of the IDF referred to as incremental damage analysis (IDA). IDA involves completing a detailed flood inundation analyses to demonstrate that failure of the dam during a candidate design storm event would not significantly increase the level of downstream flooding over that caused by the ongoing, natural flood without a dam failure. If the analysis can demonstrate that the incremental difference is minimal, a lower design step with a smaller design storm event can be used.

A preliminary estimate of the peak flow that would result from failure of the dam was estimated using the formula provided in Technical Note 2. The peak dam failure flow was estimated to be at least 22,000 cubic feet per second (cfs). A detailed flood inundation analysis is beyond the scope of this Feasibility Study. For the sake of developing conservative design recommendations that will meet DSO requirements, the Step 8 design storm with an AEP of 10^{-6} was used for the design calculations and recommendations developed in this Feasibility Study. However, completion of IDA is recommended as part of future design work because it is possible that the analysis could result in a reduction in the design storm event and resulting peak flows used, which would reduce the required size and capacity of the spillway and height of the dam.

3.5 Design Storm Calculation

Ecology's *Dam Safety Guidelines Technical Note 3: Design Storm Construction* (Technical Note 3; MGS Engineering Consultants, Inc. 2009) provides steps for developing a design storm for use in calculating the IDF hydrograph. Chapter 1.2.2 of Technical Note 3 indicates that the short-duration thunderstorm is commonly the controlling design event in Eastern Washington when the drainage area is less than 50 square miles (MGS Engineering Consultants, Inc. 2009). Short duration storms are high intensity events that typically generate very high peak flood flows. Technical Note 3 also indicates that, in Eastern Washington, the long-duration storm is usually the controlling design event for larger watersheds or when the reservoir storage capacity is large enough to attenuate runoff from the contributing watershed. For this analysis, three design storm types were evaluated: short-duration, intermediate-duration, and long-duration. The following sections detail steps that were followed to complete this evaluation using the Step 8 design storm.

3.5.1 Identify Climatic Region

The site was determined to be within Climate Region 14 using the map provided in Figure 4 of Dam Safety Guidelines Technical Note 3. The climate region was verified using the precipitation data lookup worksheets from the DSO website (DSO 2016). Copies of the precipitation data lookup worksheets are included in Appendix D.

3.5.2 Estimate Mean Annual Precipitation

The mean annual, area-weighted precipitation for the Eightmile Lake drainage basin (centroid at 47.518924° N, 120.892544° W) was estimated to be 65.1 inches. The mean annual precipitation was determined using data mapped by MGS Engineering, Inc., and the Spatial Climate Analysis Service at Oregon State University using the PRISM climate model. The mean annual precipitation was verified using the precipitation data lookup worksheets from the DSO website.

3.5.3 Estimate L-Moment Statistics

The 2-, 6-, and 24-hour duration L-moment statistics for the project site were estimated based on the location and climatic region using the precipitation lookup worksheet from the DSO website. Statistics are summarized in Table 3-1.

3.5.4 Calculate Mean At-Site Precipitation

The 2-, 6-, and 24-hour "at-site" mean precipitation values were calculated using the precipitation lookup worksheets from the DSO website. At-site precipitation values are listed in Table 3-2.

3.5.5 Calculate Base Precipitation Values

The short-, intermediate-, and long-duration theoretical maximum precipitation storm values were calculated using the L-moment statistics, at-site mean precipitation, and equations from Dam Safety Guidelines Technical Note 3, as provided in the precipitation data lookup worksheets from the DSO website. Precipitation values for each storm duration were also calculated for the various return intervals shown in Table 3-2.

**Table 3-2
Results of Precipitation Frequency Analysis**

Analysis Result	Short-Duration (2-hour) Storm	Intermediate- Duration (6-hour) Storm	Long-Duration (24-hour) Storm
L-Cv	0.1414	0.1527	0.1764
L-Skew	0.2074	0.1724	0.1666
At-site Mean Precipitation (inches)	0.726	1.513	3.367
10-year Precipitation (inches)	0.97	2.06	4.79
25-year Precipitation (inches)	1.13	2.39	5.60
100-year Precipitation (inches)	1.39	2.90	6.82
500-year (Step 1) Precipitation (inches)	1.73	3.51	8.23
Step 2 Precipitation (inches)	1.89	3.79	8.84
Step 3 Precipitation (inches)	2.19	4.28	9.87
Step 4 Precipitation (inches)	2.52	4.78	10.90
Step 5 Precipitation (inches)	2.89	5.32	11.95
Step 6 Precipitation (inches)	3.30	5.88	13.01
Step 7 Precipitation (inches)	3.75	6.47	14.07
Step 8 Precipitation (inches)	4.26	7.09	15.15

Notes:

2. For worksheets and additional detail, See Appendix D.

L-Cv: Site-specific coefficient used in Dam Safety Office (DSO) spreadsheet to calculate At-site Mean Precipitation.

L-Skew: Site-specific skew value used in DSO spreadsheet to calculate At-site Mean Precipitation.

3.5.6 *Scaling Precipitation Estimates*

The precipitation estimates were scaled for design using a design factor recommended by Technical Note 3, as shown in Equation 1:

Equation 1

$$P_{sd} = DF \times P_{gds}$$

where:

P_{sd} = Scaling precipitation for 2-, 6- or 24-hour index period, in inches

DF = Design Factor; $DF = 1.15$ for new dams

P_{gds} = Estimated 2-, 6-, or 24-hour precipitation for selected frequency, in inches

3.5.7 Calculate Total Storm Precipitation

The total storm precipitation was calculated by multiplying the scaling precipitation by a total storm multiplier based on the climatic region for the project and the hyetograph for that region and storm type, as shown in Equation 2:

Equation 2

$$\text{Total Storm Precip} = P_{sd} \times \text{Multiplier}$$

where:

Total Storm Precip = Total precipitation for the design storm, in inches

P_{sd} = Scaling precipitation for 2-, 6- or 24-hour index period, in inches

Multiplier = Multiplier from mass curve for 4-, 18-, or 72-hour storm

Table 3-3 provides a summary of the design factor, scaling precipitation, multiplier, and total storm precipitation estimated by this method using the precipitation lookup worksheets from the DSO website.

**Table 3-3
Total Precipitation for Design Storms**

	100-year Storms			500-year Storms			Step 8 (10 ⁶ -year) Storms		
	2-hour	6-hour	24-hour	2-hour	6-hour	24-hour	2-hour	6-hour	24-hour
P _{gds} (inches)	1.39	2.90	6.82	1.73	3.51	8.23	4.26	7.09	15.15
DF	1.15	1.15	1.15	1.15	1.15	1.15	1.15	1.15	1.15
P _{sd} (inches)	1.60	3.33	7.84	1.99	4.04	9.46	4.90	8.15	17.42
Multiplier	1.091	1.879	1.685	1.091	1.879	1.685	1.091	1.879	1.685
Total Precipitation for Design Storm (inches)	1.74	6.26	13.21	2.17	7.59	15.95	5.34	15.31	29.36

Notes:

DF: design factor

P_{gds}: Estimated 2-, 6-, or 24-hour precipitation for selected frequency

P_{sd}: Scaling precipitation for 2-, 6- or 24-hour index period

3.5.8 Calculate Peak Rainfall Intensity

The peak rainfall intensity for the design storms was calculated as shown in Equation 3:

Equation 3

$$\text{Peak rainfall intensity} = (\text{Total Storm Precip}) \times (\text{Peak Intensity Factor})$$

where:

Peak Rainfall Intensity = Peak rainfall intensity for the design storm, in inches/hour
Total Storm Precip = Total precipitation for the design storm, in inches
Peak Intensity Factor = Intensity factor based on climate region and storm type

The peak storm intensities are summarized in Table 3-4.

Table 3-4
Peak Storm Intensities for Design Storms

	100-year Storms			500-year Storms			Step 8 (10 ⁶ -year) Storms		
	2-hour	6-hour	24-hour	2-hour	6-hour	24-hour	2-hour	6-hour	24-hour
Total Precipitation for Design Storm (inches)	1.74	6.26	13.21	2.17	7.59	15.95	5.34	15.31	29.36
Peak Intensity Factor	2.99	0.270	0.123	2.99	0.270	0.123	2.99	0.270	0.123
Peak Storm Intensity (inches/hour)	4.79	1.69	1.63	5.98	2.05	1.97	14.71	4.14	3.62

3.5.9 Calculate Snowmelt Contribution

Floods may be produced during major rainfall events by a combination of rainfall and snowmelt. Rain on snow events typically only occur during the late winter or early spring, when only intermediate- and long-duration storms are most likely to occur. The contribution of snowmelt during the intermediate- and long-duration storms was calculated using a snowmelt spreadsheet provided by DSO (Appendix E). The snowmelt contribution was added to the total precipitation value for the design storms as shown in Table 3-5.

**Table 3-5
Snowmelt Contribution for Design Storms**

Frequency/Design Step		100-year	500-year	Step 8
Intermediate	Snowmelt (inches)	1.32	1.42	1.97
	Total Precipitation (inches)	6.26	7.59	15.3
	Precipitation + Snowmelt (inches)	7.58	9.01	17.3
Long	Snowmelt (inches)	4.45	4.65	5.52
	Total Precipitation (inches)	13.2	16.0	29.4
	Precipitation + Snowmelt (inches)	17.7	20.6	34.9

3.5.10 Calculate Design Storm Hyetograph

The design storm hyetographs were calculated based on a dimensionless unit-hyetograph. Technical Note 3 presents unit hyetographs for each storm duration and climatic region. The hyetographs are normalized so that the incremental ordinates add up to 1.0. The ordinates are then simply multiplied by the total design storm depth to obtain design storm precipitation values. Hyetographs showing the precipitation distribution estimated for the short-, intermediate-, and long-duration Step 8 design storms are plotted in Figure 3-1.

**Figure 3-1
Design Storm (Step 8) Hyetographs**

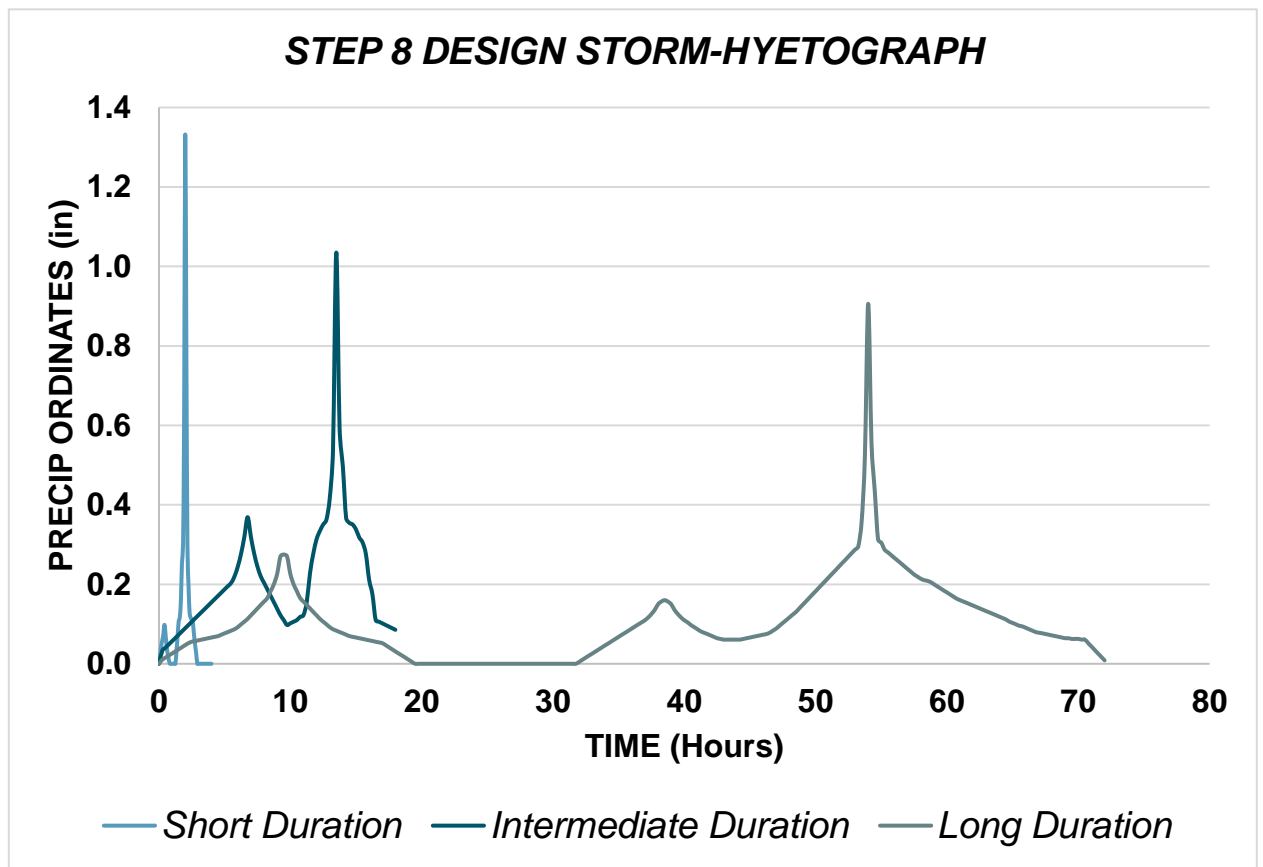

Notes:
in: inch

3.6 Design Storm Hydrologic Analysis

3.6.1 Methodology

The United States Army Corps of Engineers (Corps) Hydrologic Modeling System (HEC-HMS) software was used to estimate runoff volumes and flow rates from the drainage basin tributary to Eightmile Lake for the short-, intermediate-, and long-duration design storms characterized in Section 3.5. HEC-HMS software simulates the hydrologic processes of dendritic drainage systems and estimates hydrologic parameters, including infiltration, runoff routing, and runoff hydrographs.

The Eightmile Lake drainage basin was further divided into ten smaller sub-basins for the analysis. These were delineated using GIS software and DEM data from the USGS. The sub-basins used for the HEC-HMS analysis are shown in Figure 3-2.

Figure 3-2
HEC-HMS Sub-basin Delineation

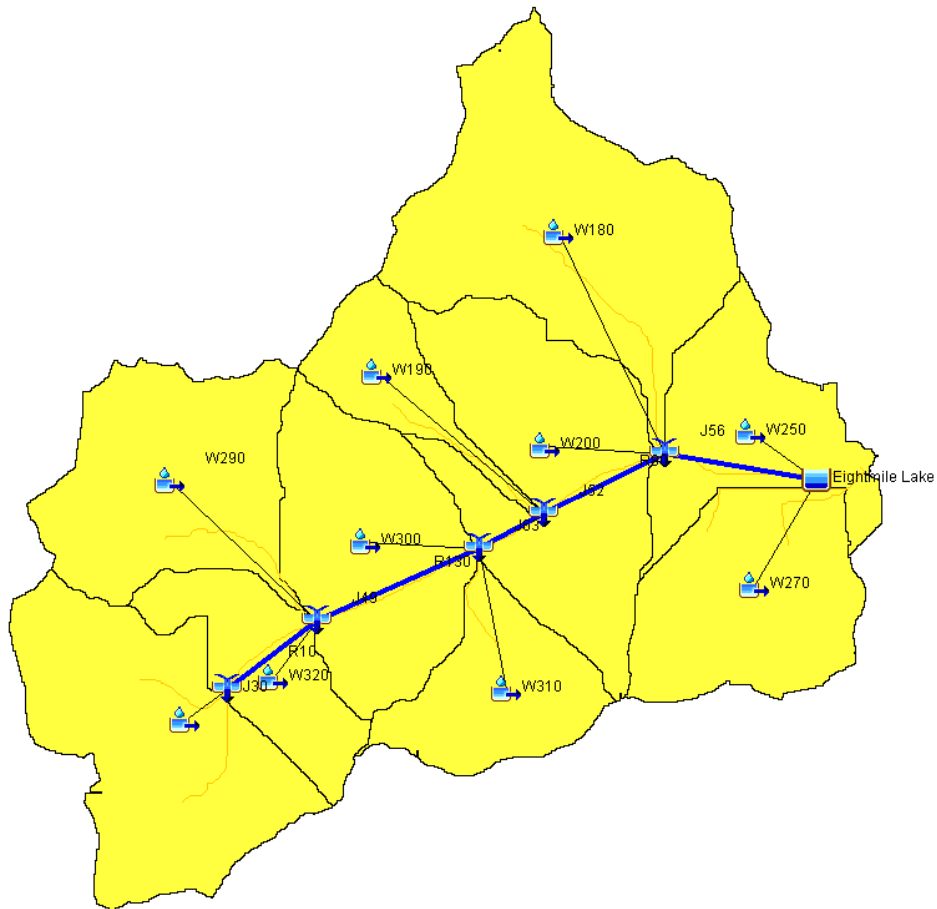

Notes:
HEC-HMS: Hydrologic Modeling System

3.6.2 Soil Characteristics and Land Cover

The NRCS Web Soil Survey (Web Soil Survey 2017) for the area was reviewed to identify the soil characteristics for each sub-basin. Soils within the drainage area as a whole are characterized as follows:

- Rock outcrop – Rubble land-Glaciers snowfields complex, 30% to 99% slopes, no Hydrologic Soil Group. This soil covers approximately 51% of the drainage and is described as having lithic bedrock at 0 inch depth.
- Andic, Cryumbrepts-Haplocryods – Rock outcrop complex, 30% to 75% slopes, Hydrologic Soil Group C. This soil type covers approximately 29% of the drainage and is categorized as

having low available water storage and is underlain by bedrock 20 to 40 inches below ground surface (BGS).

- Soda – Very boulder sandy loam, 30% to 60% slopes, Hydrologic Soil Group B. This soil group covers approximately 16% of the drainage and is described as well drained, having low available water storage (about 4.3 inches), with a vegetative classification of subalpine fir/Cascade azalea.
- Culvop – Very gravelly loam, 30% to 60% slopes, Hydrologic Soil Group D. This soil covers approximately 3% of the drainage and is described as having very low water storage and is underlain by bedrock 10 to 20 inches BGS.

A hydrologic group of C was selected for the hydrologic analysis because a majority of the 6.1 square miles of drainage area tributary to Eightmile Lake are classified as Rock outcrop complex soil types. Hydrologic Type C group soils have low infiltration rates when thoroughly wetted and consist of soils with a layer that impedes downward movement of water, or soils with moderately fine to fine textures. While the majority of the soils in the drainage have a high rate of water transmission, the underlying bedrock is relatively close to the surface.

3.6.3 Land Cover and Curve Number

The drainage area tributary to Eightmile Lake is undeveloped. Vegetation on the lower slopes tributary to the lake consist of shrubs and subalpine fir forests. The NRCS developed a method of combining the effects of soil type, topography, and land cover on the precipitation-runoff relationship into a single parameter called the runoff curve number. The HEC-HMS software uses the NRCS runoff curve number as one of the key parameters to calculate runoff. To determine the appropriate runoff curve numbers for each sub-basin, a hydrologic soil group was identified based on the soil characteristics of the site. Runoff curve numbers were estimated from Table 2-2c in the NRCS TR-55 Urban Hydrology for Small Watersheds (USDA NRCS 1986) for each sub-basin. Based on review of soil and land cover within the drainage area tributary to the lake, it was determined that site primarily contains a cover type of rocky outcrop and brush with less than 50% ground cover (poor conditions) over soils that are primarily in Hydrologic Soil Group C. Each sub-basin was assigned a composite runoff curve number that was used in the HEC-HMS model. The resulting composite runoff curve number for the entire basin was estimated at 80.

3.6.4 Estimated Inflow from Design Storm

The HEC-HMS model results for peak inflow and runoff volume for the short- (2-hour), intermediate- (6-hour), and long-duration (24-hour) design storms are included in Appendix F. Table 3-6 summarizes the key results.

**Table 3-6
Estimated Inflow from Design Storm**

	Design Storm (Step 8) Peak Inflow and Runoff Volume		
	Short	Intermediate ¹	Long ¹
Peak Inflow (cfs)	2,865	5,450	5,315
Runoff Volume (acre-feet)	890	4,460	9,535

Notes:

1. The intermediate and long duration storm values include estimated snowmelt contributions
cfs: cubic feet per second

Design storm hydrographs were generated based on the HEC-HMS model results discussed above. The short-, intermediate-, and long-duration hydrographs for the Step 8 design storm resulting from the HEC-HMS analysis are shown in Figure 3-3.

3.6.5 Comparison to USGS Methodology

Ecology DSO recommended that the results from HEC-HMS be reviewed and that a check be completed using the USGS StreamStats program. DSO suggested that the variables used to estimate the time of concentration and excess runoff method in HEC-HMS (land cover and curve number) sometimes underestimate runoff from the short-duration storm. DSO suggested that the 100-year runoff estimated by USGS StreamStats be used to calibrate HEC-HMS by comparing the StreamStats results with the HEC-HMS results. The USGS StreamStats program estimates peak flow rates at basin outlet based on precipitation data and regression equations that relate flows at the basin outlet to measured flow rates at nearby USGS gaging stations. StreamStats was used to estimate the 2-year and 100-year flow rates at the outlet of Eightmile Lake. Peak runoff at the outlet of Eightmile Lake was estimated at 195 cfs for the 2-year precipitation event and 468 cfs for the 100-year precipitation event using USGS StreamStats. Peak runoff values for the 100-year short-, intermediate-, and long-duration precipitation events calculated using HEC-HMS were 338 cfs, 1,615 cfs, and 1,961 cfs respectively. In this case, HEC-HMS underestimated the runoff from 100-year short-duration storm, due to the relatively high curve number used. The curve number is used to estimate the amount of precipitation that does not run off due to infiltration or capture by vegetation. Because less precipitation is infiltrated or captured by vegetation during a short-duration storm, using the same curve number that is used for longer duration storms can result in a low estimate of runoff from the short-duration storm. Due to the shallow bedrock in this area, a relatively high curve number was used, which resulted in a conservative estimate of the 100-year short-duration storm in HEC-HMS.

Figure 3-3
Design Storm (Step 8) Inflow Hydrographs

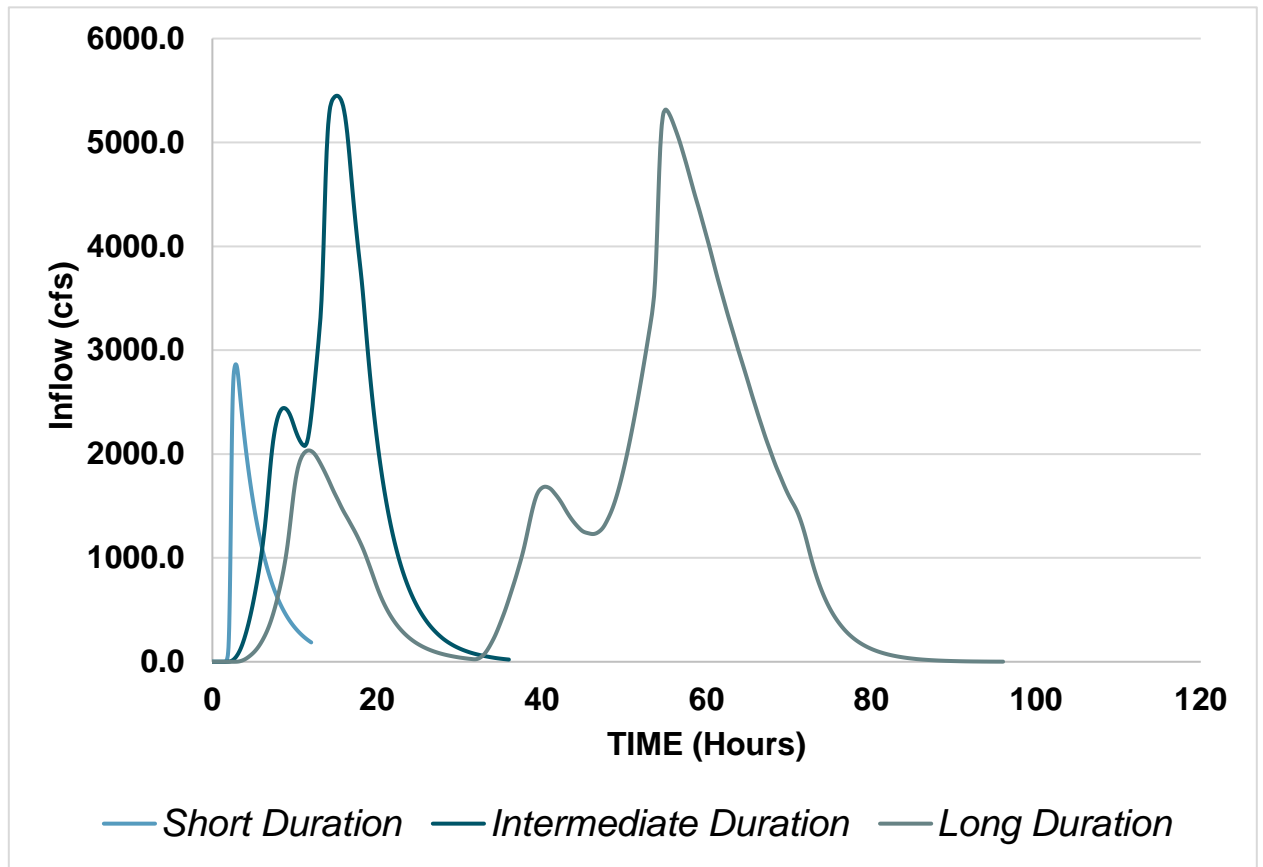

Note:
cfs: cubic feet per second

4 Eightmile Lake Storage Restoration Design

The proposed reservoir improvements and grading are shown in the feasibility-level design drawings submitted with this report (Appendix A). This section summarizes the design of the proposed improvements.

4.1 Design Criteria

IPID proposes to replace the existing dam, low-level outlet pipe, and controls to meet the following design criteria:

- **Normal High Water Surface Elevation (WSEL):** The design will restore dam facilities so that the spillway and normal high WSEL are 4,671.00 feet, equal to the historical high WSEL.
- **Useable Storage Capacity:** The design will restore the useable storage capacity in Eightmile Lake to the annual release volume allowed by IPID's water right (2,500 acre-feet).
- **Low-level Outlet Capacity:** The design will allow for controlled release of the useable storage capacity over a 60-day period with a maximum flow capacity in the low-level outlet system of at least 30 cubic feet per second cfs.
- **Controls:** The design will provide improved control of releases with a new gate or valves. The design will also provide for automation and remote control of releases by installing an electronic actuator that can be connected to telemetry for remote control from IPID's office.
- **Regulatory Requirements:** The design will comply with minimum requirements and standards of Ecology's DSO, as required to get DSO approval of a dam construction permit. The following key criteria have been identified:
 - Spillway facilities will be sized to pass the inflow design flood while maintaining a minimum freeboard of 0.75 feet.
 - Low-level outlet facilities will be designed to provide for controlled release of water while preventing seepage or uncontrolled release of water under the dam.

4.2 Site Preparation

Drawing D-01 in Appendix A illustrates the proposed work that would need to be done to prepare the site for construction. Construction of the improvements would need to occur late in the summer after the lake has been drawn down to the invert elevation of the existing low-level outlet pipeline.

The following would need to be done to prepare the site for construction:

- The lake would likely need to be drawn down further to allow improvements to be constructed "in the dry" through pumping, and dewatering facilities would need to be available to allow for dewatering of seepage water in excavations during construction.
- An area would need to be selected for staging of equipment and materials.
- Temporary erosion controls and other environmental protection measures would need to be installed prior to any disturbance and maintained throughout construction.

- Logs and debris collected at the edge of the lake along the proposed work area would need to be removed.
- The proposed construction area would need to be cleared of debris and vegetation. One of the goals of construction would be to minimize impact to native plants and vegetation, so the clearing area should be limited to just what is needed to construct the improvements.
- The existing control gate, debris rack, and related improvements would be removed.
- The rock masonry/concrete dam structure would be removed.
- The low-level outlet pipeline would be exposed by removing rock over the pipeline and excavating down to the pipe.
- The low-level outlet pipeline would be removed.

Additional detail and specific requirements for site preparation, demolition of existing facilities, and removal and disposal of materials will be included in the detailed drawings and project specifications prepared for construction.

4.3 Dam and Embankment Restoration

The project would replace the existing rock masonry/concrete dam structure and earthen embankment with new structures designed to meet the criteria specified in Section 4.2. The proposed dam and embankment restoration design is shown in the plan, profile, and section view in Drawings C-01 through C-06 in Appendix A. Key features are detailed in the following sections:

4.3.1 Central Dam and Flow/Level Control

The existing rock/concrete masonry structure will primarily be replaced with a new dam structure that will consist of a reinforced concrete core protected on both sides by an earth and rock embankment. The top of the reinforced concrete dam wall will be set at elevation 4,676.5 feet to provide freeboard over the spillway sections, as discussed in Section 4.5. Earth embankment, consisting of native material with a topping of native rocks and boulders will be placed on the upstream and downstream sides of the wall to protect the wall from debris and ice. An 8-foot wide notch in the center of the wall will allow IPID to control the lake level below the spillway elevation with stop logs similar to the form and function of the current dam. Under typical operations, IPID will remove the stop logs in the fall and the lake will fill to the crest elevation of the notch (4,666.0 feet) during the winter and spring. When the snow melts enough to allow access to the lake in the late spring or early summer, IPID will go up and place stop logs in the notch to the elevation of the spillway to allow the lake to capture late spring and early summer runoff and fill to the primary spillway elevation (4,671.0 feet). The lake would be full or near full to the spillway elevation when controlled releases begin late in the summer.

4.3.2 Primary Spillway Section

The design and sizing of spillways is detailed in Section 4.5. The primary spillway would include a 99-foot-long spillway section with a crest elevation of 4,671.0 feet, which matches the spillway elevation of the existing dam structure. The spillway section would consist of a reinforced concrete cutoff wall extending north from the reinforced concrete portion of the central dam structure. The spillway wall would be protected on the upstream and downstream sides by an earth and rock embankment. On the downstream side of the wall, the spillway would be lined with gabion baskets filled with native rock and slush concrete.

4.3.3 Secondary Spillway Section

The topography of the site indicates that there is a low spot south of the existing dam that is approximately 3 feet lower than the proposed and historical primary spillway elevation (4,671.0 feet). A secondary spillway section would be constructed in this low spot to provide additional spillway capacity, as described further in Section 4.5. The secondary spillway would include a 75-foot-long spillway section with a crest elevation of 4,673.2 feet. This spillway section would also consist of a reinforced concrete cutoff wall, protected on the upstream and downstream sides by an earth and rock embankment. Because the spillway crest would generally only extend a few feet above the existing ground surface, the extent of fill required would be limited. On the downstream side of the wall, the spillway would be lined with gabion baskets filled with native rock and slush concrete.

4.4 Spillway Analysis and Design

The primary spillway (crest elevation = 4,671.0 feet) will act as the main spillway for discharging peak flows to Eightmile Creek. The secondary spillway (crest elevation = 4,673.2 feet) was designed to provide additional capacity for flows exceeding the 100-year return interval storm inflow event. The following sections describe the approach used to size the spillway facilities.

4.4.1 Reservoir Storage and Spillway Dimensions

The HEC-HMS program was used to calculate the impact of flow routing through the improved Eightmile Lake. The crest elevations, lengths, and top elevations of the spillway and dam walls were adjusted through an iterative process to determine the spillway dimensions and elevations required to pass the Step 8 design storm peak flows from Eightmile Lake while maintaining a minimum of 0.75 feet of free board in the lake.

During the winter and spring, when the intermediate- and long-duration storm events are most likely to occur, the lake level would normally be at or below the crest elevation of the flow control notch because no stop logs would be placed in the notch until the late spring or early summer. During the early summer, with the stop logs placed in the notch, the lake level would fill to the primary spillway elevation. To reflect this, the analysis of the intermediate- and long-duration storms assumed a

starting lake level of 4,666.0 feet and the short-duration analysis assumed a starting lake level of 4,671.0 feet. The analysis also assumed that valves on the low-level outlet would be closed so that the only outflows from the lake would be through the flow control notch or the spillways. Table 4-1 summarizes the proposed flow control notch and spillway dimensions and characteristics identified as part of this analysis. The flow control notch and primary and secondary spillways will be designed to discharge flows to the existing Eightmile Creek channel east of the dam.

**Table 4-1
Spillway Dimensions and Characteristics**

Design Variable	Flow Control Notch	Primary Spillway	Secondary Spillway
Crest Length (feet)	8	99	75
Crest Elevation (feet)	4,666.0	4,671.0	4,673.2
Side Slopes (H:1V)	0	0	3
Approximate Channel Length (feet)	18	18	18
Approximate Channel Drop (feet)	2	4	1
Bed Material	Concrete Filled Gabions	Concrete Filled Gabions	Concrete Filled Gabions

Notes:

H:1V: horizontal to 1 vertical

4.4.2 Spillway Discharge Calculations

A spreadsheet was downloaded from the DSO Web Site to verify spillway channel capacity. The spreadsheet (Appendix G) uses Manning’s Equation to calculate the Froude number at set water level intervals based on the emergency spillway channel dimensions, material roughness, and channel slope. The calculations confirm that, at all stages, flow in the spillway channels will be super-critical, which means that flow at the crest of the spillways will be critical.

4.4.3 Inflow Routing Calculation

Because the flow is critical over the crest of the emergency spillway, the HEC-HMS program uses the standard broad-crested weir equation for critical flow to route flows from the lake through the spillways based on the given spillway characteristics shown in Table 4-1 and other the hydrologic inputs summarized in Section 3. The routing routine in HEC-HMS also relies on a user input stage-area-storage relationship for the lake. As part of the analysis, the lake contours from Gravity Consulting, LLC, and the proposed design were reviewed to verify the stage-area-storage relationship for Eightmile Lake with proposed improvements. The stage-storage curve for the proposed reservoir is included as Figure 4-1 with key storage and spillway elevation noted. The relationship between the water surface elevation, water surface area, and storage volume above the primary spillway crest elevation is summarized in Table 4-2.

Figure 4-1
Proposed Eightmile Lake Stage-Storage Curve

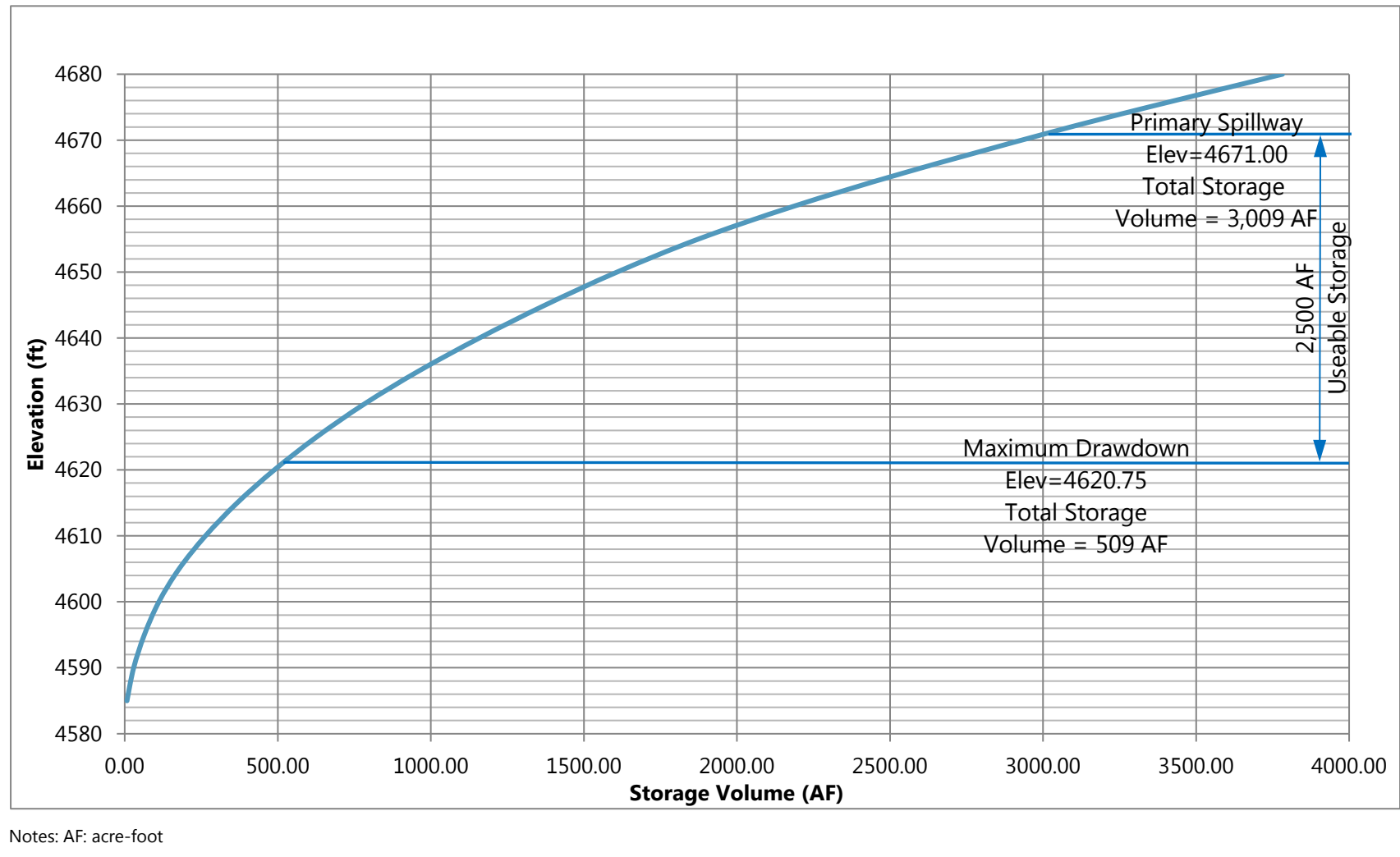
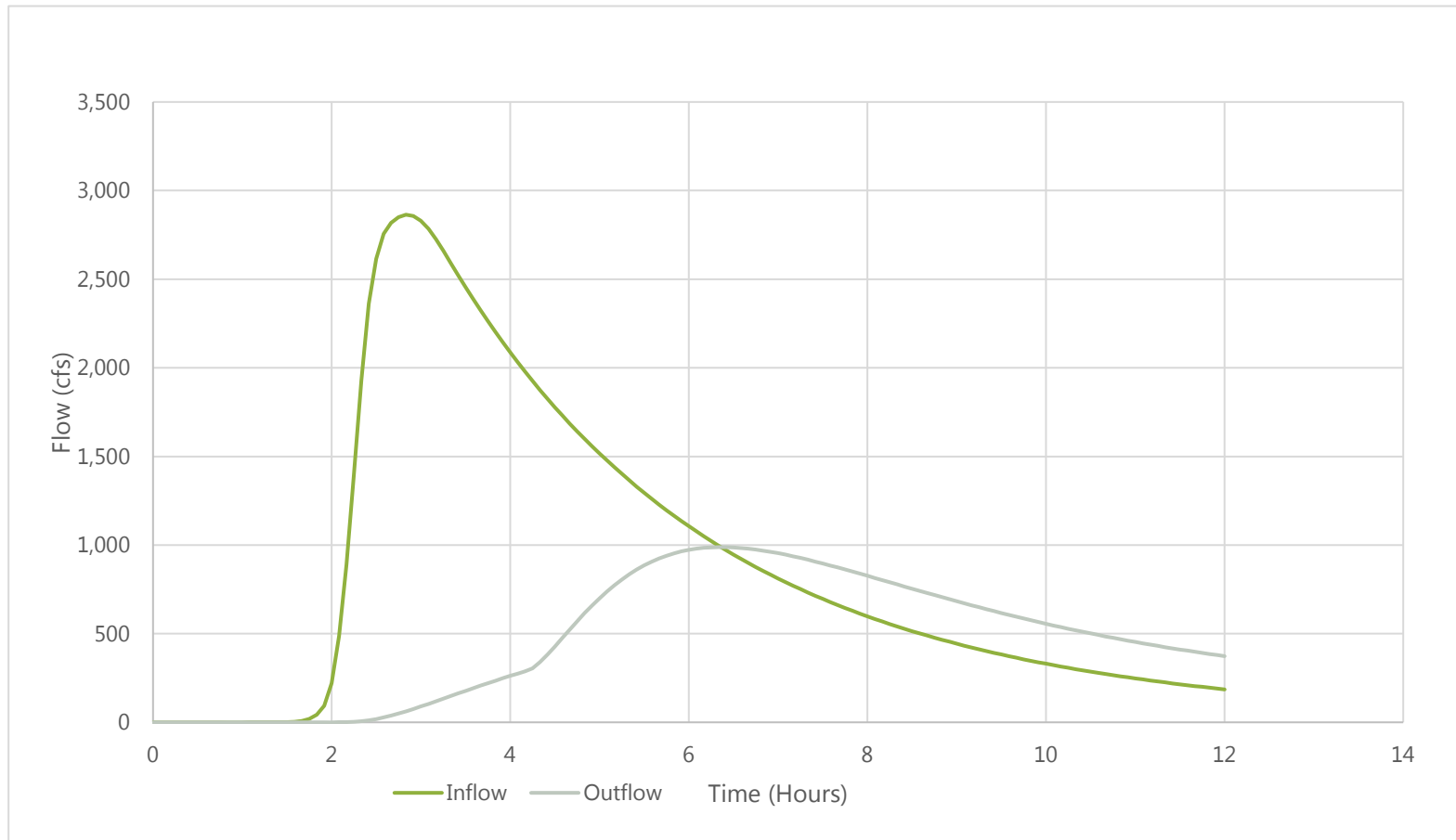

**Table 4-2
Elevation – Area – Storage Relationship Above Primary Spillway**

Elevation (feet)	Depth Over Primary Spillway (feet)	Water Surface Area (acres)	Total Storage Above Primary Spillway (acre-feet)
4,671.0	0.0	81.4	0.0
4,671.5	0.5	81.9	41.7
4,672.0	1.0	82.4	83.4
4,672.5	1.5	82.9	125.1
4,673.0	2.0	83.4	166.8
4,673.5	2.5	83.9	208.5
4,674.0	3.0	84.4	250.2
4,674.5	3.5	84.9	292.0
4,675.0	4.0	85.4	333.7
4,675.5	4.5	85.9	377.6
4,676.0	5.0	86.4	421.5

The HEC-HMS model estimates the relationship between inflows and outflows for each time step during the design storm. Inflow and outflow hydrographs were computed based on the Step 8 design storm for the short-, intermediate, and long-duration storms. The HEC-HMS routing results are summarized in Table 4-3, and the inflow-outflow relationships can be seen in Figures 4-2, 4-3, and 4-4. The results show that the peak inflow will be somewhat attenuated by the storage volume in the reservoir above the crest of the emergency spillway. Consequently, estimated peak outflows are less than peak inflows. However, the attenuation is limited, especially for the intermediate- and long-duration storms because the volume of the lake is small relative to the size of the watershed, the lake would start at full (to the primary spillway elevation), and the volume of runoff from the design storm would be much greater.

Figure 4-2
Short-Duration Storm, Inflow-Outflow Relationship



Note:
cfs: cubic feet per second

Figure 4-3
Intermediate-Duration Storm, Inflow-Outflow Relationship

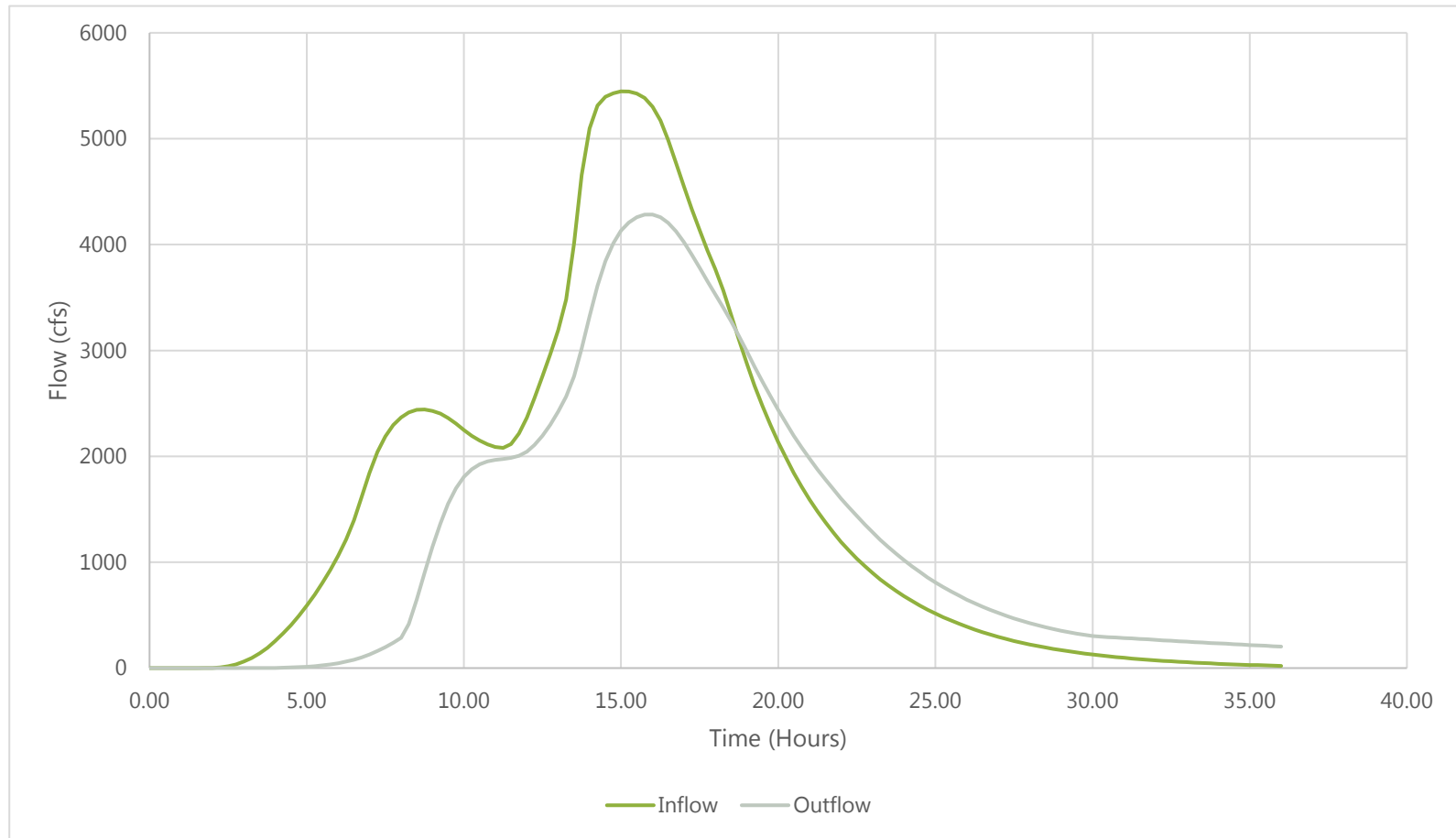

Note:
cfs: cubic feet per second

Figure 4-4
Long-Duration Storm, Inflow-Outflow Relationship

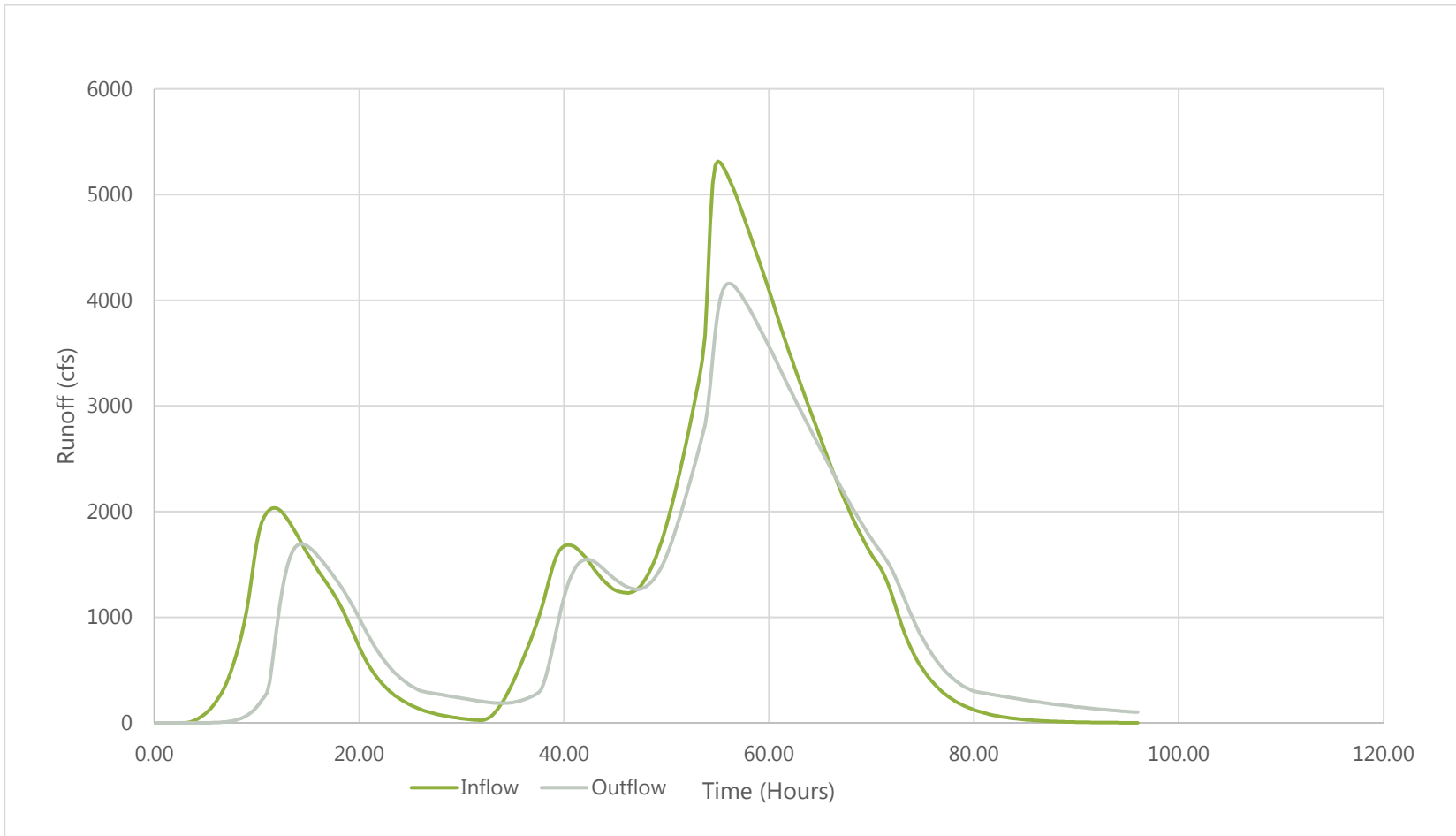

Note:
cfs: cubic feet per second

4.4.4 Inflow Design Flood Selection

With the dam and spillway configured as summarized above and shown in Drawings C-01 through C-06 in Appendix A, the intermediate-duration storm produces the highest water surface elevation and peak discharge rate over the spillways and is therefore the IDF, as shown in Table 4-3. The IDF results in a maximum WSEL of 4,675.7 feet, or 4.7 feet above the primary spillway crest elevation (4,671.0 feet) and 2.5 feet above the emergency spillway elevation (4,673.2 feet). With the top of the structure walls and embankment at 4,676.5 feet, the freeboard at the maximum WSEL is approximately 0.8 feet, which is slightly more than the required 0.75-foot minimum freeboard based on an analysis for intermediate dam freeboard.

**Table 4-3
Spillway Outflow Summary for Potential Inflow Design Storms**

	Short	Intermediate	Long
Peak Inflow (cfs)	2,864	5,447	5,315
Peak Outflow (cfs)	997	4,308	4,183.5
Peak Depth Above Primary Spillway (feet)	1.4	4.7	4.6
Peak Water Surface Elevation (feet)	4,672.4	4,675.7	4,675.6
Peak Storage Above Emergency Spillway (acre-feet)	3,031	3,314	3,305

Notes:

Results for intermediate and long storms include estimated snowmelt contribution
cfs: cubic feet per second

4.5 Low-level Outlet Pipe, Valves, and Release Controls

The proposed design also includes replacement of the low-level outlet pipeline and slide gate with a new pipeline that will be controlled by valves. The design of the low-level outlet pipeline, valves, and related controls is shown on Drawings C-07 through C-09 in Appendix A. The low-level outlet system would include the following primary components:

- Low-level Outlet Pipeline:** The pipeline would consist primarily of 30-inch (nominal diameter) butt-fused, solid-wall high-density polyethylene (HDPE) pipe, which has an average inside diameter of approximately 27 inches. The pipe would neck down to 24-inch at valve enclosures to reduce the size and cost of the proposed valves. The pipe invert would be 4,618.25 feet at the inlet, 4,645.50 feet at the dam, and 4,614.00 feet at the outlet to Eightmile Creek. When the lake is full, the pipeline would operate full under gravity to release water from the lake, despite the high point in the pipe at the dam. When the lake is drawn down below the high point in the pipe at the dam, the pipe would operate as a siphon, relying on atmospheric pressure to keep water flowing through the pipe. This would allow IPID to draw

down the lake to an elevation of 4,620.75 feet without pumping to access the full 2,500 acre-feet of storage permitted by IPID's water right.

- **Inlet Debris Rack:** A cylindrical debris rack, consisting of welded-steel or aluminum bar, would be attached to the pipe inlet to keep debris from entering the pipeline.
- **Pipe Anchoring:** Approximately 380 feet of pipeline would be installed along the lake bottom. The pipe would likely be installed by floating the pipe on the lake and then filling the pipe with water so that it drops and rests along the lake bottom. The pipe would require anchoring to prevent the pipe from floating when water is evacuated from the pipe.
- **Encasement:** The proposed pipe would be buried from the lake to the outlet in Eightmile Creek. The pipe would be encased in reinforced concrete under the dam and embankment.
- **Isolation Valve Enclosure:** A 24-inch gate valve would be provided in an enclosure on the downstream side of the dam to allow IPID to isolate the pipeline below the dam. The isolation valve would be designed to be either fully open or closed. The valve would be left open during normal operations and would be closed only when needed to maintain the pipeline downstream of the valve. The valve enclosure would also include an air release valve on the upstream side of the isolation valve that would allow for the release of air from the pipeline as it fills with water over the winter and spring. A vacuum pump would be provided with a connection to the pipeline for use in priming the pipeline, in the event that the siphon breaks when the lake level is drawn down and releases are occurring. The enclosure would also include a sump pump to evacuate water. Power for the vacuum pump and sump pump would come from batteries charged by a nearby solar panel. The enclosure would consist of a 60-inch-diameter pipe riser with a weathertight, locking lid and an access ladder.
- **Control Valve Enclosure:** A 24-inch plug valve would be provided to control flow through the pipeline near the downstream end of the pipeline. The valve would be closed during the winter, spring, and early summer. As the lake fills, the pipeline would fill behind the valve. In the late summer the valve would be adjusted to release flows to Eightmile Creek. The plug valve would be equipped with an electronic actuator and connected to telemetry to allow for automated releases to be controlled by IPID via radio from their office in Cashmere. Automation of releases from the Alpine Lakes is detailed in the *Feasibility Study, Alpine Lakes Optimization and Automation* report (Aspect 2017), which is being prepared concurrent with this report. The actuator would be powered by batteries charged by a nearby solar panel. The enclosure for the valve, actuator, batteries, and controls would consist of a 60-inch-diameter buried pipe riser with a weathertight, locking lid above the ground surface and an internal access ladder.

As outlined in the Dam Safety Guidelines Part IV: Dam Design and Construction, there are five primary concerns for the hydraulic design of low-level outlet pipelines:

- The inlet invert elevation of the low-level outlet must be selected so as to sufficiently evacuate reservoir storage while remaining free of sedimentation.
- Sufficient discharge capacity should be provided for the project demands and future needs.
- Sufficient discharge capacity should be provided to allow for drawdown of the reservoir in a reasonable period of time for emergencies, maintenance, inspections, and repair of reservoir elements that would normally be submerged.
- The design should provide features to reduce slug flow potential.
- The design should provide redundant and repairable valves and shut-off capabilities to allow for conduit inspection and repairs, and prevent unintended release of storage waters if a system component were to fail.

4.5.1 Hydraulic Analysis

Table 4-4 summarizes the key design parameters for the low-level outlet pipeline. Hydraulic analysis of the low-level outlet indicates that the pipeline would generally have capacity to release water at rates in excess of 30 cfs. When the lake is full, the control valve would need to be partially closed to limit releases. For example, if the lake were full to the spillway elevation (4671.00 feet), the control valve would need to be closed to 40° to restrict the discharge to Eightmile Creek to less than 36 cfs. As the lake draws down, flow through the pipeline would decrease until the valve would need to be fully open to release 30 cfs. If the lake were drawn down to an elevation approaching the pipe inlet, the capacity would drop further. For example, if the lake were fully drawn down to the top of the pipe at the inlet (4,620.75 feet), with the valves fully open and the siphon fully primed, the pipeline would be able to discharge nearly 18 cfs to Eightmile Creek.

**Table 4-4
Low-level Outlet Pipeline Analysis**

Parameter	Design Value
Low-level Invert Elevation at Outlet to Channel	4,614.00 feet
Outlet Water Surface Elevation at Channel	4,614.00 feet
Low-level Invert Elevation at Dam	4,645.50 feet
Low-level Inlet Invert Elevation at Lake	4,618.25 feet
Nominal Pipe Diameter	30 inches
Nominal Pipe Diameter at Valves	24 inches
Pipe Material	Solid-wall HDPE, butt-fused
Pipe Length	844 feet
Q _{min} with Lake Surface at 4,620.75 (Fully Drawn Down, Siphon Flow)	17 to 18 cfs
Q with Lake Surface at 4,623.25 (Drawn Down, Siphon Flow)	~30 cfs
Q with Lake Surface at 4,671.00 (Lake Full, Valve Closed at 40°)	35-36 cfs
Q with Lake Surface at 4,671.00 (Lake Full, Valve Fully Open)	>100 cfs

Notes:

cfs: cubic feet per second

HDPE: high-density polyethylene

Q: flow rate

Q_{min}: minimum flow rate

4.6 Reservoir Operations

Table 4-5 summarizes the anticipated operation of the controls at the proposed dam and on the low-level outlet. The lake would fill during the late fall, winter, and spring to the crest elevation at the bottom of the flow control notch. When the snow melts and the lake is accessible in the late spring or early summer, IPID would place stop logs in the notch to the elevation of the primary spillway and the lake level would continue to rise to the spillway level through the early summer. When additional flows are needed in Icicle Creek, the control valve would be opened. The control valve would be adjusted remotely by IPID to optimize releases to meet instream flow and irrigation water supply needs. The operation of the low-level outlet would transition from gravity flow to siphon as the lake level drops below the high-point on the pipeline (elevation 4,645.5 feet). At the end of the irrigation season the control valve would be closed, the stop logs would be removed, and the system would be winterized. If the lake has been fully drawn down and the siphon breaks, the low-level outlet would fill as the lake refills over the winter. The air release valve located at the high-point of the pipeline near the dam would release air trapped in the pipe as it fills with water.

**Table 4-5
Anticipated Reservoir Operations**

Month	Storage Level	Stop Logs in Flow Control Notch ¹	Low-level Outlet Pipe Operation ²	Isolation Valve Status ³	Control Valve Status ⁴
January	Refill	Removed	Closed/Filling	Open	Closed
February	Refill		Closed/Filling	Open	Closed ⁴
March	Refill/Spill		Closed/Filling	Open	Closed ⁴
April	Refill/Spill		Closed/Filling	Open	Closed
May	Refill/Spill		Closed/Filling	Open	Closed
June	Refill	Placed to 4,671.0	Closed	Open	Closed
July	Full (4,671 Max)		Release Begins	Open	Partially Opened
August	Draw Down		Gravity Release	Open	Partially Opened
September	Draw Down		Gravity/Siphon Release	Open	Fully Opened
October	Low (4,621 Min)	Remove	Closed	Open	Closed
November	Refill		Closed/Filling	Open	Closed
December	Refill		Closed/Filling	Open	Closed

Notes:

1. Stop logs would be placed in the flow control notch in late spring, early summer to the spillway elevation when snow has melted and the lake is accessible. Stop logs would be removed at the end of the release period in early October.
2. Releases through the low-level outlet would occur during the late summer, with initial release operating fully under gravity flow conditions and late in the summer under siphon flow conditions.
3. The isolation valve would remain open unless the downstream end of the pipe needs to be isolated for maintenance.
4. The control valve would be used to control releases from the low-level outlet. It would generally remain closed until the late summer and then adjusted to release flows to match needs in Icicle Creek during the late summer. If desired the valve could be operated to allow for some release to meet Leavenworth National Fish Hatchery water supply needs during the winter low flow period.

4.7 Restored Useable Storage Capacity

The proposed improvements would restore the useable storage capacity in Eightmile Lake to 2,500 acre-feet, which is the annual volume permitted for release by IPID’s water right. If the total usable storage is released over a 60-day release period, the average flow release would be approximately 21 cfs. Automation of the control valve will allow for remote control and adjustment of releases to more closely match the need for additional water downstream in Icicle Creek. The actual period of release will vary from year to year and the magnitude of the releases will be modified throughout the release period to meet water supply needs.

Figure 4-5 illustrates the new high and low water surfaces that would result from implementation of the proposed project, as reflected in the feasibility level design drawings. When the lake is full to the primary spillway elevation (4,671.00 feet), the water surface area of the lake will be approximately 81.4 acres. When the lake is drawn down to the top of the low-level outlet pipe at the inlet (4,620.75 feet), the water surface area of the lake will be approximately 26.5 acres. When the lake is

drawn down to the invert of the existing low-level outlet pipe, the water surface area is approximately 47.9 acres. However, as noted earlier, the lake continues to draw down due to seepage. Forsgren Associates, Inc., and Gravity Consulting, LLC, estimated the low draw-down elevation to be approximately 4,644 feet, which corresponds to a water surface area of approximately 44.1 acres.

SOURCE: Aerial Image from ESRI
HORIZONTAL DATUM: Washington State Plane North, NAD83, U.S. Feet.

- LEGEND:**
- Water Surface at Elev.=4,671.00 (Proposed and Historical Spillway Elevation)
 - Water Surface at Elev.=4,644.00 (Estimated Current Low Water Surface Without Pumping or Siphon)
 - Water Surface at Elev.=4,620.75 (Proposed Maximum Drawdown)

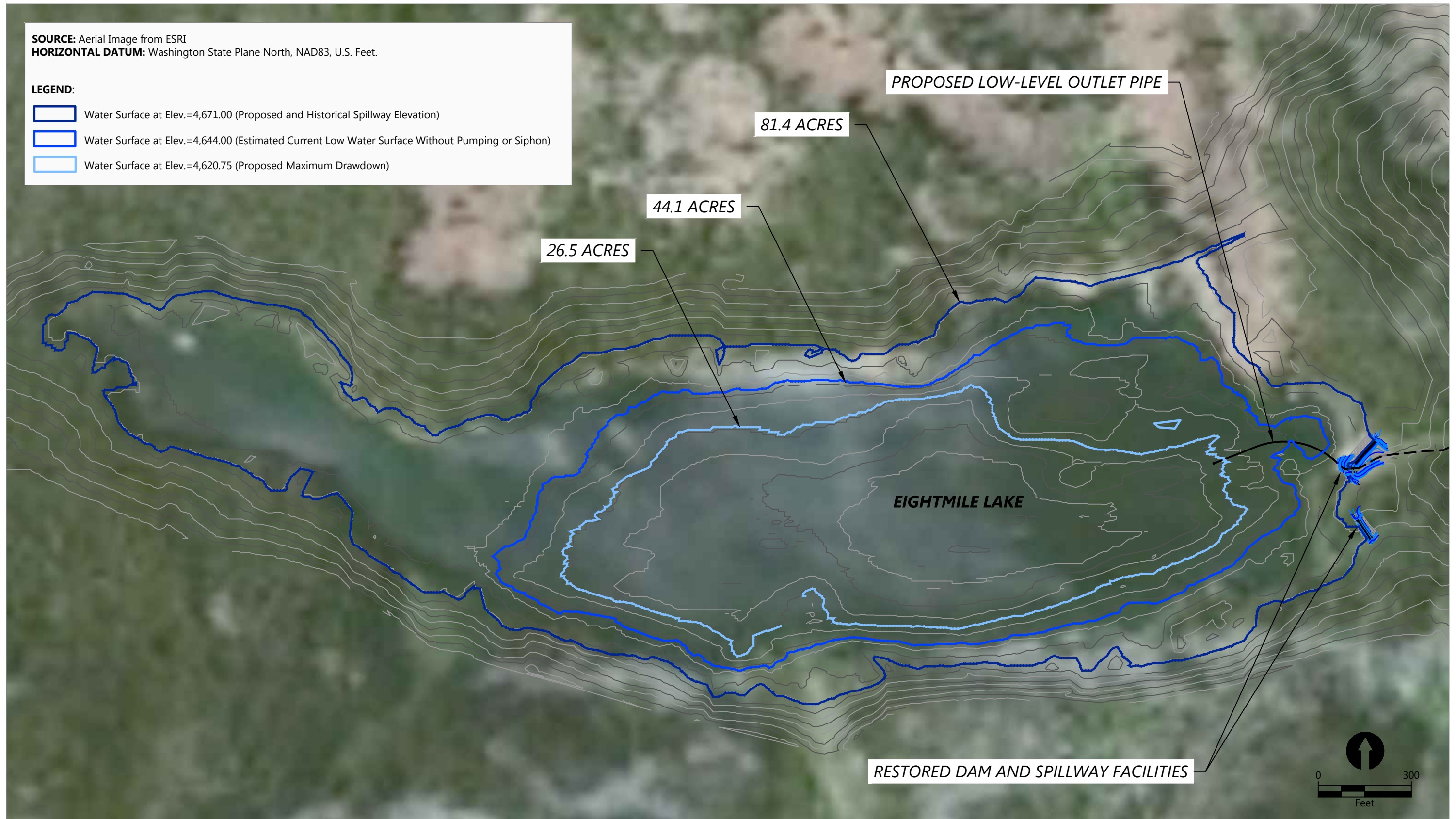

Publish Date: 2018/04/30 3:23 PM | User: drice
Filepath: K:\Projects\0204-Aspect Consulting, L.L.C\Icicle Creek Comp Water Mgt\Eightmile Lake\0204-RP-001 FS FIG 4-5.dwg FIG 4-5



Figure 4-5
Eightmile Lake Water Surface Area Comparison
Eightmile Lake Feasibility Study
Icicle and Peshastin Irrigation Districts

5 Construction Approach

5.1 Constraints and Limitations

The primary challenge to implementation of the proposed Eightmile Lake Storage Restoration project will be determining how to construct the project at a remote location within the Alpine Lakes Wilderness Area that is not accessible by roads. The project will require careful planning to secure appropriate permits and ensure that the project can be constructed safely to meet the requirements of the design. The primary constraints and limitations that will need to be addressed are construction access; mobilization of the work crew, provisions, equipment, and materials; delivery and control of materials to meet specification requirements; and constructing the project within what could be a very tight window between when the lake is drawn down and when the snow falls.

5.2 Access and Mobilization

As noted earlier and shown in Figure 1-1, Eightmile Lake is located 10 miles west of the City of Leavenworth, Washington. The lake is situated within Sections 32 and 33, T24N, R16E, and is entirely within the Alpine Lakes Wilderness Area. There are no roads that access the lake directly. The lake can be accessed on foot via the Eightmile Lake Trail (USFS Trail No. 1552). The trailhead is accessible from Leavenworth by vehicle following Icicle Road, USFS Road 7600, and USFS Road 7601. The distance from the trailhead to the lake is approximately 4 miles.

For routine maintenance and access, IPID accesses Eightmile Lake on foot. To complete maintenance at multiple lakes and for activities that require more equipment than can be easily carried on foot, IPID accesses the lakes via helicopter. Typically, that access is provided with a small helicopter with a payload of 1,000 to 2,000 pounds, which limits the number of people and amount of gear that can be transported in one trip. IPID has used helicopters recently to access nearby Colchuck Lake to perform more intense maintenance activities that have required the transport of a small work crew, hand tools, camping gear, food and provisions for the work, sacks of concrete, other materials, mixing equipment, and a generator. Transporting the work crew, other equipment, and materials has typically required multiple trips in a small helicopter.

5.3 Access Options

The proposed Eightmile Lake Storage project would require access by a work crew and transport of gear, food and provisions, hand tools, larger mechanical equipment (including at least one excavator, a small tracked loader, a means of mechanically sorting on-site materials, and possibly concrete mixing equipment), concrete, pipe, valves, generators, dewatering pumps, trench protection equipment, debris rack, and other construction materials. To the extent possible, rock and earthen material would be sourced from on site. Transporting larger mechanical equipment and some of the

other construction materials that will be required to the site will likely require access via one of the following methods.

5.3.1.1 Helicopter

Transport of larger equipment and materials would require a much larger helicopter than what is used by IPID for typical maintenance. Columbia helicopters provides helicopter transport services for heavy lift, firefighting, and military applications. Columbia helicopters was contacted to understand the costs and limitations associated with use of helicopters to haul equipment and materials to the site (Dave Horax 2017). They provided the following information on options for helicopter transport:

- **Columbia Vertol 107-II:** The Vertol 107-II is a tandem rotor aircraft with a maximum gross weight of 22,000 pounds. The maximum payload at the elevation of the proposed project would be approximately 7,000 to 8,000 pounds. Mobilization of the helicopter and pilot would carry a \$20,000 fee. The rental fee would be \$7,500 per hour.
- **Columbia Chinook CH-47D:** The Chinook CH-47D is a tandem rotor aircraft with a maximum gross weight of 50,000 pounds. The maximum payload at the elevation of the proposed project would be approximately 20,000 to 22,000 pounds. Mobilization of the helicopter and pilot would carry a \$45,000 fee. The rental fee would be \$15,000 per hour.
- **Columbia 234-UT:** The 234-UT is also a tandem rotor aircraft with a maximum gross weight of 51,000 pounds. The maximum payload and costs for mobilization and rental would be similar to the cost for the Chinook CH-47D.

Other helicopter options exist that can carry similar payloads, but there are relatively few options that have a payload capacity similar to the Chinook CH-47D. With a payload capacity of 20,000 to 22,000 pounds, the Chinook CH-47D would have capacity to carry most of the materials and equipment. However, the challenge will be transporting an excavator that is large enough to efficiently move the material needed to remove and replace the existing dam and low-level outlet pipeline. For example, the largest Cat excavator that weighs less than 22,000 pounds would be a Cat 308E2 excavator, with an operating weight of 18,519 pounds. The 308E2 is a 65-horsepower machine and is classified as the largest of Cat's mini excavators. Other equipment that may need to be flown in by helicopter could include a small tracked multi-terrain loader.

One of the other key challenges will be transporting concrete; either the concrete would have to be batched on site with on-site water, or the concrete would have to be batched off-site, hauled to a pick-up location near the site, and transported via helicopter to the site. Columbia helicopters indicated that the Chinook CH-47D does not have a big bucket or hopper for transporting concrete. However, the Vertol 107-II helicopter has a bucket that can hold 1-1/2 yards of concrete.

5.3.1.2 Combined Helicopter/Overland Transport

Another option might include transport of smaller gear, equipment, and lighter materials with a small to medium-sized helicopter and walking a larger excavator to the site. A larger excavator would be able to complete the work much more efficiently, and transport overland would be much less expensive. However, this approach would likely have more of an impact on the environment along the trail to Eightmile Lake. Walking the excavator would consist of shifting the weight from the bucket to the tracks to maneuver the excavator over rocks, logs, and earth in a way that would minimize the impact on vegetation and other natural resources. IPID has proposed to investigate this option with the USFS to identify an overland route that would have least impact. IPID has indicated that there is a historical roadbed that was used in the past for access to Eightmile Lake that extends from Eightmile Lake Road up the slope almost to the boundary of the Alpine Lakes Wilderness. The existing Eightmile Lake Trail (USFS Trail No. 1552) ascends a steep slope from the trailhead and then uses this historic road bed as it extends west to the Alpine Lakes Wilderness Area. The historical road bed could be used as a route to transport the excavator part of the distance to Eightmile Lake. Where the trail narrows and enters the Alpine Lakes Wilderness Area, the excavator could be carefully maneuvered over rocks and logs near the base of the slope, parallel to but off the trail, where there is less vegetation that would be disrupted.

A couple of different types of excavators were investigated as options for this approach:

- **Standard Tracked Excavator:** The work required to restore storage at Eightmile Lake would be most effectively done with a medium- to large-sized tracked excavator, such as a Cat 330. This type of excavator moves on a heavy base with tracks and uses the tracks to distribute weight and travel over surfaces that are highly variable. IPID has a medium-sized excavator, as do most local contractors that would do this type of work.
- **Spider Excavator:** Another option may be to use a spider excavator. A spider excavator has legs with rubber-tired wheels, rather than a base with tracks. The legs and rubber-tired wheels allow for greater maneuverability. Some spider excavators come equipped with telescopic hydraulic stabilizing jacks that can extend from the front legs to stabilize the equipment for work on steep terrain. Spider excavators are often used on ski slopes and in remote mountain terrain, similar to the terrain around Eightmile Lake. Use of a spider excavator would likely have less impact on the environment, but would not likely provide the same horsepower, lifting, and digging capacity as a standard tracked excavator. Spider excavators are also less common, and so use of this type of excavator would likely limit the number of contractors that would be able to do the work. A contractor was contacted in California that does spider excavation all over the Western United States. The cost for the excavator and an operator would be \$200 to \$250 per hour, depending on the size of machine, plus a \$200 per day per diem rate and a mobilization/demobilization fee of \$5,000.

5.3.2 Comparison

Table 5-1 provides a summary and comparison of the potential approaches to accessing the site and delivering equipment and materials to the site.

**Table 5-1
Potential Construction Access and Mobilization Approach Comparison**

Access and Mobilization Approach	Large Helicopter, Small Excavator	Overland Access, Tracked Excavator	Overland Access, Spider Excavator
Mobilize Crew, Provisions	Small Helicopter or Trail	Small Helicopter or Trail	Small Helicopter or Trail
Mobilize Equipment	Small Helicopter	Small Helicopter	Small Helicopter
Mobilize Excavator	Large Helicopter	Walk Overland	Walk Overland
Mobilize Excavator	Large Helicopter	Small-Medium Helicopter	Small-Medium Helicopter
Type of Excavator	Small Excavator	Medium-Large Excavator	Spider Excavator
Excavator Example	Cat 308E2	Cat 330F	Menzi Muck M545
Excavator Weight	20,000 Pounds Max	60,000 Pounds+	25,000 to 30,000 Pounds
Excavator Horsepower	65 hp	235 hp	180 hp
Excavator Max Dig Depth	13 to 14 feet	23 to 24 feet	15 to 30 feet ¹
Impact to Environment	Least impact to area between trailhead and Eightmile Lake	Most impact to area between trailhead and Eightmile Lake	Some impact to area between trailhead and Eightmile Lake
Cost	Highest due to Helicopter Mobilization, Rental	Lowest	Slightly Higher than Standard Excavator
Equipment Limitations	Helicopter Payload; Excavator Size, Power, and Lifting Capacity	Excavator Maneuverability	Excavator Size, Power, and Lifting Capacity
Contractor and Equipment	Requires Specialized Helicopter, Pilot; Could Transport Other Equipment, Like a Small Tracked Loader	Standard Contractor, Standard Equipment	Specialty Contractor, Specialty Excavator
Work, Efficiency	Least Efficient due to Small Excavator	Most Efficient (Except that mobilization would take more time)	Medium Efficiency (Mobilization would also take time)

Notes:

1. Excavation depth depends on chassis configuration and position relative to ground slope.

hp: horsepower

5.4 Materials Delivery and Staging

The proposed project will require a variety of materials, including earth, rock, concrete, reinforcement, pipe, valves, valve enclosures, a debris rack, stop logs, an actuator, a vacuum pump,

risers, solar panels, batteries, controllers, and other miscellaneous equipment. The following challenges will arise related to material delivery and quality control during construction:

- **Earthwork** – To the extent possible, native material should be used to construct the embankment and backfill excavations. Typically, specifications for materials placed for a dam structure or backfill adjacent to a structure have requirements for the size distribution of materials, compaction, moisture content, and other characteristics. The quality of these materials is managed by reviewing the materials prior to placement and performing compaction tests to ensure that materials are properly placed. Ensuring that on-site materials meet specific requirements will be a challenge for this project because the site is so remote. Sorting materials properly will be difficult because there will be a limit to the type of mechanical sorting equipment that can be brought to the site. Compaction testing equipment will have to be flown in and a certified testing agency will need to access the site regularly.
- **Concrete** – The project will require placement of approximately 168 cubic yards of concrete. As noted previously, concrete will either need to be flown in or batched on site. The benefits and challenges of flying in the concrete would include the following:
 - The concrete would be batched in a plant to meet the specifications.
 - The time between batching and placing the concrete could push acceptable limits. Depending on where concrete is batched, it would likely take more than an hour to transport concrete to a pick-up point, transfer the concrete to the hopper on the helicopter, and fly the concrete to the site.
 - Managing the moisture content throughout the transport would be a challenge.
 - Helicopters have limited capacity, so many trips would need to be made to transport concrete. The limited delivery rate would make the work less efficient.
 - There would be potential for pollution in flying concrete in a helicopter, so pollution controls would need to be implemented.

The benefits and challenges of batching the concrete on site would include the following:

- The concrete would not need to be transported long distances.
 - The dry concrete materials, including cement and aggregate, would have to be flown in, which would add complexity and time to the mobilization effort.
 - Quality control of the material would be very challenging. It would be almost impossible so that the concrete placed consistently meets the material specifications.
 - It would be difficult to manage the quality of the water used in the concrete mix.
 - On-site water would need to be used for the concrete mix, which may not be of consistent or appropriate quality for the concrete mix.
 - Batching on site would have potential for pollution and would require controls.
 - Space would need to be identified on site for mixing concrete and staging materials.
- **Other Equipment** – Pre-fabricated or manufactured materials and equipment would need to be transported to the site via helicopter and staged in a safe place prior to installation. HDPE

pipe would need to be transported in segments small enough for helicopter transport and then joined on site with a butt fusion machine. Valves, valve enclosures, a debris rack, stop logs, an actuator, a vacuum pump, risers, solar panels, batteries, controllers, and other miscellaneous equipment would all need to be transported in loads that were within the limitations of the helicopter. This may require some on-site assembly.

5.5 Construction Sequence and Scheduling

Sequencing of construction will be critical because the schedule for completing the work will be limited by the following:

- **Lake Drawdown** – The work at the lake will need to be completed after the lake has been drawn down well below the existing low-level outlet so that work can be completed “in the dry”. Typically, the lake is not drawn down until late summer, when IPID releases water to maintain irrigation water supply. However, during the year the improvements are constructed, IPID may need to manage its other reservoirs to allow for early drawdown of Eightmile Lake. The draw down will still be constrained by the natural hydrologic cycle. If there is above average snow pack and a cool spring weather, the lake may still be capturing a lot of natural runoff well into late June or early July.
- **Weather** – Due to the location and elevation of Eightmile Lake, snow often begins to fall in October, although significant snow accumulation typically does not occur until November. Freezing weather may occur much earlier in the fall. In addition, October rainfall can result in runoff that would impact the lake level and the Contractor’s ability to keep the site dry for construction. The Contractor will have to sequence and manage construction so that the project can be constructed in dry conditions and is substantially complete before significant snow accumulation or extended freezing weather occurs.

Ultimately, it is recommended that the construction specifications and contract documents be prepared so the selected Contractor as much flexibility as possible in determining the appropriate means and methods, schedule, and sequence for construction. Some of those means and methods, such as how materials and equipment are mobilized, where materials are staged, and what kind of controls will need to be in place to protect the environment, will likely be limited by permit approvals. However, to the extent possible, it will be beneficial to IPID and project funders to provide as much flexibility as possible to prospective bidders to figure out how to get the work done within the limitations dictated by the permit requirements and natural constraints at the site.

6 Cost Analysis

6.1 Summary of Probable Implementation Costs

Table 6-1 summarizes the opinion of probable project implementation costs for the project. A more detailed breakdown of the opinion of probable costs is included in Appendix H. The opinion of probable costs includes the following assumptions and allowances:

- An allowance of 10% of the construction subtotal (without helicopter costs) for general mobilization/demobilization.
- A separate allowance for helicopter mobilization and rental fees, as described below.
- A 20% contingency for the low estimate and a 40% contingency for the high estimate.
- A 20% allowance for engineering, permitting, and construction administration.
- A sales tax at 8.2%.

**Table 6-1
Opinion of Probable Project Implementation Costs**

Item	Cost
Site Preparation	\$ 42,000
Demolition of Existing Facilities	\$ 126,000
Install Low-Level Outlet and Valves	\$ 449,000
Rebuild Dam and Embankment	\$ 591,000
Automate Valves to Optimize Releases ¹	\$ 45,000
Construction Subtotal²	\$ 1,253,000
General Mobilization/Demobilization (10%)	\$ 125,300
Helicopter Mobilization/Demobilization/Rental	\$ 390,000
Construction Total²	\$ 1,768,000
Contingency – LOW (20%)	\$ 353,600
Contingency – HIGH (40%)	\$ 707,200
Engineering, Permitting, and Administration	\$ 353,600
Sales Tax	\$ 144,976
Project Total - LOW^{2,3}	\$ 2,620,000
Project Total - HIGH^{2,3}	\$ 2,974,000

Notes:

1. Cost associated with installing monitoring equipment and telemetry connection to Icicle and Peshastin Irrigation Districts are included in the opinion of probable project costs for the Alpine Lakes Optimization and Automation project, as reported in the *Feasibility Study: Alpine Lakes Optimization and Automation* (Aspect 2017) and are not included here.
2. Subtotals and totals are rounded to the nearest \$1,000.
3. Costs are represented in May 2017 dollars. Actual costs may vary based on labor rates, equipment costs, and materials costs at the time of construction.

6.2 Helicopter Mobilization and Rental

The opinion of probable project costs assumes that helicopters would be used to mobilize materials and equipment to the site, as discussed in Section 5. As noted earlier, Columbia Helicopters was contacted to get updated preliminary budget information on the cost of hauling equipment and materials to the site via helicopter. Table 6-2 summarizes the likely helicopter mobilization and rental costs that would be associated with this approach.

**Table 6-2
Likely Helicopter Mobilization and Rental Costs**

Type of Helicopter	Payload	Mobilization Fee	Rental Fee
Small ¹	1,000 to 2,000 pounds	--	\$15,000 per day
Columbia Vertol 107-II ^{1, 2}	7,000 to 8,000 pounds	\$20,000	\$7,500 per hour
Columbia Chinook CH-47D ^{1, 2}	20,000 to 22,000 pounds	\$45,000	\$15,000 per hour

Notes:

1. Actual prices may vary based on availability of helicopters at the time of construction.
2. Provided by Columbia Helicopters.

The costs assume the following:

- A helicopter with a large payload, similar to the Chinook CH-47D, would be used to haul a small excavator, a tracked multi-terrain loader, and any other relatively heavy equipment and materials to the site to facilitate the work. Costs assume helicopter mobilization and 6 hours of use at the beginning and mobilization and 4 hours of use at the end of the project.
- A small helicopter with a payload of 1,000 to 2,000 pounds, contracted from a local helicopter company, would be used to transport provisions, smaller equipment, and personnel. This would require up to 10 total days of use during the project.
- Concrete materials would be mixed on site for the dam replacement project at Eightmile Lake. The alternative would be to haul ready-to-pour concrete via helicopter to the site, which would likely be accomplished with a smaller helicopter and more helicopter trips.

6.3 Long-term Operating Costs

The following are the costs to operate and maintain the new facilities:

- Regular maintenance and repair of valves, monitoring equipment, and communications equipment
- Repair and servicing of the power supply system (rechargeable direct current (DC) solar/battery power system)
- Inspection and repair of the new low-level outlet pipeline and related equipment

- One 2-day trip to the lake in the late spring to clear debris, place stop logs to capture the late spring early summer runoff, and perform preliminary start-up activities
- One 2-day trip to the lake in the fall to winterize the facilities
- Other short trips, as needed, to address operational issues, inspect the facilities, perform routine maintenance and cleaning, and prime the siphon in the event that the siphon pressure and flow break

Operation and maintenance of the proposed facilities would likely require more effort than the current facilities. However, remote operation of the facilities could reduce the number of trips required to access the lake because trips would not need to be made to adjust the gate to control releases. A conservative allowance of 0.5% of the total project cost was considered as a guideline for annual operations and maintenance costs (in 2017 dollars). Based on this guideline, operations, and maintenance costs would be on the order of \$15,000 per year. This level of operations and maintenance would cover a 2-day trip to place stop logs and perform preliminary start-up activities in the late spring, a 2-day trip to winterize the facilities in the fall, two additional 1-day visits to the lake per year by IPID personnel to perform routine maintenance and resolve operational issues, and an allowance for cleaning, inspection, and repair of equipment at Eightmile Lake. The long-term operating costs would likely increase with inflation.

7 Water Rights

This section provides a summary of IPID’s water rights and provides recommendations and guidance for additional work needed to prepare a change application to accommodate any changes in use of the water needed to be consistent with the goals and intent of the Icicle Strategy.

7.1 History

In 1926 Icicle Irrigation District (IID) filed an application with the state Office of Supervisor of Hydraulics (an Ecology predecessor agency) requesting to divert water from Eightmile Lake for seasonal irrigation. A petition was also filed with the Department of Public Lands (a Department of Natural Resources predecessor) to procure the shore and overflow rights to the lake¹. The Office of Supervisor of Hydraulics issued a permit (Permit 828) in January 1927 to develop the lake source. Following payment of fees to cover damages to state lands from overflow of the lake, the Department of Public Lands then issued an Order dated October 26, 1927, which reads in part: “the right to overflow and perpetually inundate said lands [Eightmile Lake] may be duly exercised in accordance with the terms of this order², the lands included being more particularly described as follows: The bed and shores of Eight Mile Lake.”

In 1927, water rights to Icicle Creek and its tributaries were adjudicated in Chelan County Superior Court. The 1929 Final Court Decree affirmed IID’s water right permit for Eightmile Lake in the amount of 25 cfs, 2,500 acre-feet. The decree noted that the water right represented by the permit was “inchoate but may be perfected by compliance with provisions under which the permits were issued; that these rights for storage of water under said permits do not affect the water rights of any other claimant herein reported.”

The storage right was subsequently certificated (Certificate 1228) by the Office of Supervisor of Hydraulics for 25 cfs for the purpose of irrigation of 7,000 acres; no annual quantity was specified on the certificate. The 2,500 acre-feet of annual storage volume specified in the Court Decree establishes the maximum authorized storage volume.

In the *Draft Icicle Irrigation District Instream Flow Improvement Options Analysis Study*, Forsgren Associates, Inc., and Gravity Consulting, LLC, estimated that the current high water mark corresponds to a usable storage volume of approximately 1,375 acre-feet, whereas the top of dam overflow elevation represents a usable volume of 1,666 acre-feet. Based on preferential operation of the lake early in the season, IPID can obtain approximately 300 acre-feet of additional capacity below the

¹ Additional applications and petitions were concurrently filed for use of water from Klonaqu Lake and Colchuck Lake.

² No specific terms were spelled out in the Order. The Order references Section 102, Chapter 255 of the Session Laws of 1927. This chapter and section authorized the Commissioner of Public Lands to grant the right to “back and hold water” and overflow and inundate state shore lands for the purpose of constructing and operating works for the impoundment of water for irrigation and other uses.

gravity outlet by relying on natural seepage in the late summer/early fall. The total lake volume is 2,700 to 3,000 acre-feet at these corresponding water surface levels, which is in excess of the 2,500 acre-feet permitted to be stored and beneficially used under IID's water right. In dry years, it is possible for IID to augment its usable storage volume by drawing down the lake further than the normal outlet elevation through additional mechanical or gravity means. The water right record is unclear whether IID's water rights are single-fill storage rights, or whether they can rely on additional natural flows to augment storage, which would further enhance the beneficial use history of the water right. If additional water right authority were needed to augment storage to meet Guiding Principles under an Icicle Integrated Plan, it is possible that additional spring filling water rights could be granted by Ecology because water is routinely available in excess of adopted instream flows during this time period.

In 1990 IPID and the USFS agreed to a land exchange where the USFS received title to IPID's interest in lands adjacent to Eightmile Lake. Lands at Eightmile Lake conveyed to USFS are described as Section 5, Lots 1 and 2 of Township 23 N, Range 16 EWM and Section 33, Lot 1 of Township 24 N, Range 16 EWM. These descriptions correspond to an approximately 40-acre-square parcel at the lake outlet and dam structure and an approximately 80-acre rectangular parcel along the south shore of the lake (see Figure 2-3). Under the land exchange agreement recorded with the Chelan County recorder's office IPID retained several rights to the land, including the following:

A nonexclusive, perpetual easement across, through, along, and upon the property described herein for the purposes of maintenance, repair, operation, modification, upgrading and replacement of all facilities presently located in or upon the property described herein, together with a nonexclusive right of ingress to and egress from all such facilities for all such purposes, in accordance with Rules and Regulations of the Secretary of Agriculture, 36 CFR 251.17 and 251.18, attached hereto and made a part hereof, in such manner as not unreasonably to interfere with its use by the United States, its authorized users or assigns, or cause substantial injury thereto.

The Grantor [IPID] may exercise the rights hereunder by any means reasonable for the purposes described, including but not limited to the use of motorized transportation and equipment, or aircraft. These rights include the right to regulate water level of all facilities located upon the property described herein. In performing maintenance, repair, operation, modification, upgrading and replacement of facilities located in or upon the property described herein, the Grantor will not without prior written consent of the Forest Service, which consent shall not unreasonably be withheld, materially increase the size or scope of the facilities.

The recorded deed further recognized that IPID reserved their rights under water right Certificate 1228 and the Order granted by the Commissioner of Public Lands.

7.2 Water Right Change Strategy and Process

The proposed project would convert this historical irrigation use to a combination of instream flow and municipal uses, while retaining irrigation use authority with uses matched to water availability in different types of water years according to the IWG Guiding Principles. A key element to the water right change strategy is obtaining a new secondary use permit to authorize the reoperated water uses. Under this proposal, the total restored quantity (2,500 acre-feet), will be placed into the trust water rights program for instream flows and mitigation through the issuance of a new secondary use permit. This trust water right will be managed through a trust water right agreement that will stipulate in drought years that up to 1,600 acre-feet will be available to IPID for irrigation. In non-drought years, this water will remain instream for environmental benefit. Annually, up to 900 acre-feet of consumptive use will be available for new mitigated permits to the City of Leavenworth and Chelan County to support domestic use.

Additional secondary use permits can be issued per the guidelines laid out in Revised Code of Washington (RCW) 90.03.370. New secondary use permits are subject to the four-part test:

1. Availability: If storage is restored to the original high water mark, water will be available for this use.
2. Impairment: This new secondary use permit is non-diversionary and non-consumptive in nature. Increased stream flow will not likely impair senior water users.
3. Public Interest: Ecology has found on numerous occasions that increased stream flows are in the public interest. Other public interest factors would need to be considered including recreation, aesthetics, wilderness values, and others. These are being considered more fully in the PEIS.
4. Beneficial Use: The legislature has determined that instream flows and mitigation are a beneficial use in Chapter 90.38 RCW and 90.42 RCW. So too are irrigation, domestic, and municipal uses under RCW 90.54.020.

Applying for a secondary use permit will require the parent water right, Certificate 1228, to undergo a tentative determination of extent and validity. This will require consideration of beneficial use, relinquishment, and abandonment, which has not occurred since the adjudicated water right was issued. If there are periods of 5 years or more where underutilization has occurred, the statutory exemptions provided in RCW 90.14.140 would need to be examined for applicability. Because this is primarily a storage right, Ecology will consider whether 2,500 acre-feet per year was impounded and stored. The amount of water released will also inform that analysis.

8 Environmental and Permitting Strategy

A preliminary environmental and permitting evaluation was completed as part of the *Appraisal Study, Eightmile Lake Storage Restoration* (Anchor QEA 2015). That evaluation identified natural resources that could be impacted by the proposed project, summarized potential impacts and regulatory requirements, and provided a list of anticipated permits that would be required to complete the project. As noted in Section 1, the Anchor QEA/Aspect team is currently working toward completion of the *Icicle Strategy Programmatic Environmental Impact Statement*. The PEIS evaluates five alternatives and a no-action alternative. The alternatives each include a suite of projects that are collectively intended to meet the IWG Guiding Principles. The Eightmile Lake Storage Restoration Project is included as a component of three of the five action alternatives evaluated by the PEIS. Another alternative includes an Eightmile Lake Storage Enhancement Project, which is a different project than what is evaluated by this Feasibility Study. The Eightmile Lake Storage Enhancement Project would include facilities that would increase the accessible storage in Eightmile Lake to 3,500 acre-feet by raising the spillway elevation of the dam and increasing drawdown.

As part of the work done for the PEIS, detailed field investigations were completed during a series of July 2016 site visits to verify the natural and cultural resources that could be impacted by the project. The PEIS includes detailed information about these resources and identifies potential impacts to these resources that would result from construction of the improvements to Eightmile Lake. Two supporting reports, the *Icicle Creek Water Resource Management Strategy Draft Cultural Resources Discipline Report* (Anchor QEA 2017a) and the *Icicle Creek Water Resource Management Strategy Draft Natural Resources Discipline Report* (Anchor QEA 2017b) were prepared to summarize field observations and provide additional data to support the conclusions of the PEIS.

This section summarizes the findings of the work that was done to support the PEIS related specifically to the Eightmile Lake Storage Restoration Project, provides an updated table listing the likely permitting and regulatory requirements, and recommends a strategy for securing the necessary permit approvals to construct the project.

8.1 Affected Environment and Anticipated Impacts

The following provides a summary of the resources that would likely be affected by the Eightmile Lake Storage Restoration project, as proposed in this Feasibility Study, and the potential impacts to those resources that could result from the work. Additional detail is provided in the *Icicle Strategy Programmatic Environmental Impact Statement*.

8.1.1 Geology

The geology at the proposed project site was summarized in Section 2.6 and shown in Figure 2-2. Geology is characterized by shallow rocky soils over bedrock or exposed bedrock. A relative large

mass wasting deposit near the outlet of Eightmile Lake includes loose rock and large boulders. On-site rock will be needed for dam and embankment construction. Overall, impacts on geology will be local to the project site and are not anticipated to be significant.

8.1.2 *Water Resources and Water Use*

The hydrology of the Eightmile Lake drainage basin is described in detail in Section 3. The proposed project will capture and store a portion of the natural winter, spring, and early summer runoff for release during the late summer to improve late summer flow conditions in Lower Icicle Creek. There is potential for some minor short-term water quality impacts, such as increased turbidity, from ground disturbance and placement of new dam materials during construction. Temporary erosion and sediment controls, spill prevention control, and other water quality controls would be installed to protect the water in Eightmile Lake during construction, in accordance with permit requirements and existing water quality standards. The potential impacts would also be minimized by drawing down the lake to construct improvements in the dry. The long-term impacts to downstream hydrology would generally be beneficial as the changes are designed to optimize releases to benefit natural resources in the Icicle Creek Sub-basin.

8.1.3 *Aquatic Habitat and Species*

Eightmile Lake is within a group of mountain lakes managed in Washington as “high lakes,” which have historically lacked suitable spawning habitat or productive conditions for rearing juvenile fish. These lakes likely did not support fish populations until they were introduced for sport fishing by humans. Until 2005, Eightmile Lake had been stocked with cutthroat trout (*Oncorhynchus clarki lewisi*), rainbow trout (*O. mykiss*), and lake trout (*Salvelinus namaycush*). Fish abundance and stocking are tracked by Washington Department of Fish and Wildlife (WDFW) with the help of volunteer organizations. Invertebrates are a major source of food for fish and trout feed primarily on zooplankton and benthic invertebrates.

Eightmile Lake discharges to Eightmile Creek, which is a tributary to Icicle Creek. The Icicle Creek Corridor provides approximately 29 miles of spawning and rearing habitat for salmon and trout species, including Endangered Species Act (ESA)-listed Upper Columbia spring-run Chinook salmon (*O. tshawytscha*), Upper Columbia summer steelhead (*O. mykiss irideus*), and bull trout (*Salvelinus confluentus*). Passage for migratory fish species is blocked at several locations downstream of Eightmile Lake. Passage for migratory species is generally limited above the Icicle Creek Boulder Field at River Mile 5.6. Another project proposed as part of the Icicle Creek Strategy would modify the Boulder Field to improve passage and access to spawning and rearing habitat for anadromous fish species. Resident fish populations of bull trout, cutthroat trout, rainbow trout, and other species of minnows, sculpins, and suckers occupy Icicle Creek above the Boulder Field. Although bull trout and other fish species have been observed in the lower reaches of Eightmile Creek, passage is unlikely in

the upper reaches of Eightmile Creek because the stream has a very steep gradient from Little Eightmile Lake to the lower reach of Eightmile Creek near its confluence with Icicle Creek.

The reoperation of the lake would generally result in increased habitat for resident fish in Eightmile Lake in the early summer and decreased habitat in the late summer. However, because existing fish populations in the lake are likely to be low, impacts would not be significant.

Impacts on fish and other aquatic species likely to be present below Eightmile Lake within Eightmile and Icicle Creek are expected to generally be beneficial because the project would optimize releases from Eightmile Lake to improve passage and habitat conditions in Icicle Creek. Implementation of activities as part of the Tribal and Non-Tribal Fisheries project would further help to ensure there are no significant impacts on tribal fishing.

8.1.4 Vegetation

The Alpine Lakes area is dominated by forested habitat with species such as silver fir (*Abies amabilis*), subalpine fir (*Abies lasiocarpa*), Engelmann spruce (*Picea engelmannii*), and mountain hemlock (*Tsuga mertensiana*) in the upper elevation areas. Avalanche chutes are brushy with deciduous species such as Sitka alder (*Alnus sinuata*), vine maple (*Acer circinatum*), and Rocky Mountain maple (*Acer glabrum*). Lower elevations include Douglas fir (*Pseudotsuga menziesii*), western white pine (*Pinus monticola*), ponderosa pine (*Pinus ponderosa*), shore pine (*Pinus contorta*), western hemlock (*Tsuga heterophylla*), and western red cedar (*Thuja plicata*) (USFS 2016; Franklin and Dyrness 1973). All of these species were observed during a reconnaissance site visit to Eightmile Lake in July 2016.

Dominant shrub and understory species observed during the July 2016 site visit include Scouler willow (*Salix scouleriana*), Cascade azalea (*Rhododendron albiflorum*), twinberry (*Lonicera involucrata*), white spirea (*Spiraea betulifolia*), red huckleberry (*Vaccinium parvifolium*), kinnikinnick (*Arctosaphylos uva-ursi*), and western thimbleberry (*Rubus parviflorus*).

Existing mapping does not identify wetland habitats within the vicinity of Eightmile Lake. During the July 2016 site visit, wetland conditions were not observed at the outlet location, but several potential palustrine emergent, palustrine scrub-shrub, and palustrine forest wetland features were observed along the lake shoreline.

Short-term impacts to existing vegetation may include removal and disturbance of trees and bushes to accommodate the improvements to the dam and low-level outlet pipeline. In addition, short-term impacts could include clearing, removal, or disturbance of vegetation needed for overland access to the site with an excavator, if that option is pursued. Implementation of best management practices, such as clearing limits and protection of existing vegetation, would be implemented to protect vegetation. Long-term impacts would include inundation of area that was historically inundated, but has not recently been inundated by Eightmile Lake. This could impact existing vegetation along the

shoreline of the lake in areas that were historically inundated but have not recently been inundated. However, the area around the lake that would be impacted would be relatively small. As noted previously, the project would also result in an increase in downstream flows within Eightmile and Icicle Creeks. Downstream impacts are anticipated to be beneficial for riparian vegetation along this corridor. Overall, the project is not anticipated to result in significant long-term adverse impacts on vegetation or wetlands.

8.1.5 Wildlife

Wetlands and riparian areas associated with the Alpine Lakes and receiving streams provide habitat for a variety of amphibians, such as Pacific tree frog (*Pseudacris regilla*), western toad (*Anaxyrus boreas*), tailed frog (*Ascaphus truei*), Cascades frog (*Rana cascadae*), Columbia spotted frog (*Rana luteiventris*), and long-toed salamander (*Ambystoma macrodactylum*). Reptiles, such as the western garter snake (*Thamnophis elegans*), are likely to occur in the upland habitats surrounding the lake. Upland habitats with rocks and wood debris support species such as northern alligator lizard (*Elgaria coerulea*) and western fence lizard (*Sceloporus occidentalis*). Common garter snakes (*Thamnophis sirtalis*) and northern alligator lizards were observed during the July 2016 site visit.

Mammal species associated with forested habitats at the Alpine Lakes area include mountain beaver (*Aplodontia rufa*), bobcat (*Lynx rufus*), hoary marmot (*Marmota caligata*), fisher (*Martes pennanti*), Douglas squirrel (*Tamiasciurus douglasii*), voles (*Microtus spp.*), pika (*Ochotona princeps*), and striped skunk (*Mephitis mephitis*). Larger mammals, such as elk (*Cervus elaphus*), black-tailed deer (*Odocoileus hemionus*), black bear (*Ursus americanus*), cougar (*Felis concolor*), and coyote (*Canis latrans*), are also found in the forested habitat. Mountain goats (*Oreamnos americanus*) are found in the high-altitude areas. Deer tracks and scat were frequently observed during the July 2016 site visit.

Forested habitats around Eightmile Lake provide foraging and nesting habitat for a wide variety of bird species, including songbird species, migratory bird species, and others. Predatory birds, such as bald eagle (*Haliaeetus leucocephalus*), red-tailed hawk (*Buteo jamaicensis*), and osprey (*Pandion haliaetus*), commonly hunt in these habitat types and occur in forested areas near bodies of water. The lake environment can be expected to provide habitat for belted kingfisher (*Ceryle alcyon*) and wintering and migratory waterfowl, including gadwall (*Anas strepera*), American widgeon (*Mareca americana*), mallard (*Anas platyrhynchos*), common loon (*Gavia immer*), and western grebe (*Aechmophorus occidentalis*).

Construction activity could temporarily disrupt the use of riparian and forested habitat by native wildlife species to breed, forage, rest, and overwinter. The greatest potential for short-term impacts on wildlife would occur as the result of increased noise during construction. Short-term increases would include some helicopter trips, movement and processing of on-site earth and rocks, and possibly blasting. The majority of construction noise would be relatively minor. In general, most

wildlife species are expected to disperse in response to periodic increases in noise and activity to adjacent habitat areas to avoid impacts. However, particularly vulnerable species may include those that may be breeding during this time. Construction scheduling and other practices would be implemented, as required by applicable permits, to minimize impacts during construction.

As noted above, long-term impacts would include inundation of area that was historically inundated, but has not recently been inundated by Eightmile Lake. This could impact wildlife along the shoreline of the lake as the result of periodic decreases in wildlife habitat when this area is flooded. However, the area impacted would be relatively small and is expected to occur for few months each spring. Overall, the project is not anticipated to result in significant long-term impacts on wildlife.

8.1.6 Cultural Resources

As part of the July 2016 reconnaissance site visits performed to assess conditions at the Alpine Lakes for the PEIS, an archaeological survey was completed at Eightmile Lake. This survey included a pedestrian survey and recordation of irrigation structures.

The survey revealed no cultural resources along the existing Eightmile Trail. However, at Eightmile Lake, the dam and low-level outlet facilities were recorded as a historical water release system. Along with the outlet facilities a Square Lake, Colchuck Lake, and Klonauqua Lake, the Eightmile Lake facilities were recommended as eligible for listing on the National Register of Historic Places (NRHP), based on the following criteria:

- Criterion A for the facilities association with historically significant and controversial water management in Chelan County
- Criterion B for the unique style influenced by the extremely difficult terrain and constraints of mid-century construction methods
- Criterion D for the potential to yield data about early twentieth century engineering and construction

No cultural resources were observed along the margins of the lake or within the existing width of the trail to the project site. No sacred sites (Native American ceremonial areas or natural landmarks) or sites recorded as Traditional Cultural Properties were identified at or near Eightmile Lake.

The improvements will modify the dam and low-level outlet facilities by removing the existing facilities and replacing them with new facilities. These activities would require compliance with various local, state, and federal regulations, which address in part the protection of cultural resources. If deemed necessary, compliance with these regulations could result in the development of mitigation measures to reduce cultural resources impacts in coordination with the Washington State Department of Archeology and Historic Preservation (DAHP).

8.2 Anticipated Permitting Requirements

For the purpose of this Feasibility Study, likely permitting requirements and the anticipated permitting process for the improvements to Eightmile Lake were identified. Table 8-1 lists the anticipated permits and approvals that will need to be secured for the project.

**Table 8-1
Anticipated Eightmile Lake Storage Restoration Project Permitting Requirements**

Permit	Agency	Apply with the JARPA (Y/N)	Permits Needed	Notes
Section 404 Permit ¹	Corps	Y	✓	Triggered by excavation in or placement of fill material into waters of the United States
NEPA Review ¹	Corps	N	✓	NEPA review would be triggered by the Corps CWA review.
USFS Special Use Permit	USFS	N		Authorizes uses on National Forest Service land that provide a benefit to the general public and protect public and natural resources values. Not required for work inside IPID easement, but could be required if work extends outside IPID easement.
ESA Section 7 Concurrence ²	NMFS and USFWS	N	✓	This review is triggered by the Section 404 permit. The Corps would coordinate with NMFS and USFWS as needed to ensure potential impacts on fish and wildlife species are adequately addressed. It is anticipated that potential adverse impacts on downstream ESA-listed fish would be minimized through implementation of a long-term management plan for flow releases.
Magnuson-Stevens Fishery Conservation and Management Act Concurrence ²		N	✓	
Fish and Wildlife Coordination Act Concurrence ²		N	✓	
NHPA Section 106 concurrence, Archaeological Resources Protection Act Permit ²	Corps and DAHP	N	✓	This review is triggered by the Section 404 permit. If significant adverse impacts are identified, consultation between the Corps, DAHP, IPID, and potentially affected tribes would be required to ensure the impacts are adequately addressed.
Section 401 Water Quality Certification ³	Ecology	Y	✓	Triggered by excavation in or discharge dredge or fill material into water or isolated wetlands.
Dam Construction Permit ⁴	Ecology	N	✓	Required for dams and supplemental structures impounding or controlling more than 10 acre-feet of water.
Water Right Change Permit ⁵	Ecology	N	✓	Required for dams and supplemental structures impounding or controlling more than 10 acre-feet of water.
Ecology Sand and Gravel Permit ⁶	Ecology	N	✓	Needed for projects that quarry on-site sand and gravel for use in construction to reduce construction costs.
Burn Permit ⁷	WDNR	N	✓	May be required if project calls for burning of on-site cleared debris and logs, per WDNR requirements.

Permit	Agency	Apply with the JARPA (Y/N)	Permits Needed	Notes
Hydraulic Project Approval ⁸	WDFW	Y	✓	Triggered by work below the ordinary high water mark in waters of the state.
Aquatic Use Authorization	WDNR	Y	✓	Triggered by work affecting bed/flow of state waters. This may not be required and should be confirmed.
NPDES Construction Stormwater General Permit ⁹	Ecology	N	✓	Triggered by clearing, grading, and/or excavation resulting in the disturbance of 1 or more acres and discharges stormwater to surface waters of the state.
Shoreline Substantial Development Permit ¹⁰	Chelan County	N	✓	Per the Chelan County Shoreline Management Plan, possible exemption for modification of existing agriculture facilities.
SEPA Determination	Chelan County	N	✓	SEPA determination to be made for Icicle Strategy PEIS, which includes the Eightmile Lake Storage Restoration project. Subsequent project-level review may be required but is expected to be streamlined.
Critical Areas Ordinance Compliance ¹¹	Chelan County	N	✓	Per the Chelan County Shoreline Management Plan, possible exemption for construction of irrigation structures.
Fill and Grade, Building Permits ¹¹	Chelan County	N	✓	Required by Chelan County.

Notes:

1. Corps NWP / NEPA Categorical Exclusion are the likely level of regulatory compliance for this project. Compliance with General Conditions 20 would require completion of a preconstruction notification, acknowledging potentially eligible resources pursuant to the National Historic Preservation Act; however, given the nature of the activities, it is anticipated that minimal review would be required. The preconstruction notification is fulfilled by filling out the Washington JARPA. Eightmile Lake is not a navigable waterway per Corps guidance and therefore does not require a Section 10 permit.
2. The Corps permit evaluation will address consistency with these regulations.
3. Streamlined review (e.g., approval letter) issued when CWA NWP conditions are adhered to.
4. Ecology Dam Safety Office review requiring submittal of engineering plans, specifications, and reports.
5. Required for adding instream flows as secondary uses.
6. Needed if on-site gravel would be quarried for construction to save costs.
7. A permit to burn cleared logs would only be required if it exceeded the specifications (i.e., fire content, size, and timing limitation) set forth by WDNR.
8. Compliance handled through the JARPA review process and expected to be minimal.
9. General permit anticipated, requiring compliance with general conditions.
10. A Shoreline Substantial Development Permit may not be required. This needs to be confirmed with Chelan County. Past operations and maintenance activities have most often resulted in Chelan County issuing approval versus a formal Shoreline Substantial Development Permit.
11. Permits may not be required. Need to confirm with Chelan County. It is possible that Ecology review if required as indicated in Note 4 would suffice to support Chelan County's approval.

Corps: U.S. Army Corps of Engineers
CWA: Clean Water Act
DAHPP: Washington State Department of Archaeology and Historic Preservation
Ecology: Washington State Department of Ecology
ESA: Endangered Species Act
IPID: Icicle and Peshastin Irrigation District
JARPA: Joint Aquatic Resource Application
NEPA: National Environmental Policy Act
NHPA: National Historic Preservation Act
NMFS: National Marine Fisheries Service
NPDES: National Pollutant Discharge Elimination System
PEIS: Programmatic Environmental Impact Statement
SEPA: State Environmental Policy Act
USFS: U.S. Forest Services
USFWS: U.S. Fish and Wildlife Service
WDFW: Washington Department of Fish and Wildlife
WDNR: Washington Department of Natural Resources

8.3 Recommended Permitting Approach

In Anchor QEA's experience, project objectives, constraints, and challenges are communicated early on in the project to save time and effort required to respond to comments and questions from regulatory reviews later in the design process. Initial outreach and coordination has occurred as the result of developing the PEIS and many of the regulatory agencies listed in Table 8-1 are generally aware of the overall Icicle Creek Strategy. However, as the details of the Eightmile Lake Storage Restoration Project become further developed, it is recommended that a pre-planning meeting with a focused group of agencies occur to discuss the project to more clearly understand regulatory constraints and confirm the assumptions identified in Table 8-1 and discussed further in this section.

Anchor QEA recommends that this initial meeting occur with the Corps³ and include Ecology, WDFW, and Washington Department of Natural Resources (WDNR). The timing of this meeting should occur 12 months prior to beginning construction to allow sufficient time for the appropriate permits/approvals to be secured. This timeline assumes that compliance with the Clean Water Act (CWA) and the National Environmental Policy Act (NEPA) could be addressed through a nationwide permit and Categorical Exclusion. The remainder of this section discusses the permitting triggers and thresholds relevant in the consideration of developing an efficient and coordinated project-level permitting strategy.

Because the project would include work within waters of the United States and of the state of Washington, environmental review related to the following permits/approvals is expected to be required:

- CWA Section 404 permit by the Corps
- CWA Section 401 certification by Ecology
- Hydraulic Project Approval review by WDFW
- Aquatic Use Authorization by WDNR (may not be required)

Review to support these permits/approvals would be initiated by submittal of the Washington Joint Aquatic Resource Permit Application (JARPA). This would provide the initial information the regulatory agencies listed above would need to be able to review the project.

Submittal of the JARPA to the Corps would also trigger their environmental review under NEPA, ESA, the Magnusson-Stevens Fisheries Act (MSA), the Fish and Wildlife Coordination Act (FWCA), and the National Historic Preservation Act. To provide sufficient information to the Corps to be able to consult with the appropriate agencies (e.g., U.S. Fish and Wildlife Service [USFWS], National Marine Fisheries Service [NMFS], and DAHP), IPID would develop and submit a preconstruction notification (PCN), which would be fulfilled through completion of the JARPA. Once the Corps has received initial

³ It is Anchor QEA's understanding that the proposed work would occur within the existing IPID easement and while upfront coordination with USFS should be completed, USFS would not take the lead on ensuring compliance with the required federal permits/approvals.

project information, it is recommended that additional coordination meetings occur with USFWS, NMFS, and DAHP, focusing on the issues identified below.

Because the field survey completed in July 2016 identified the Eightmile Lake dam and low-level outlet facilities for listing on the NRHP, this information must be disclosed in the PCN and it is likely formal consultation with Washington State DAHP will be required. Consultation and review of all projects that comprise the alternatives outlined in the *Icicle Strategy Programmatic Environmental Impact Statement* will be initiated with DAHP as part of the PEIS review process. Specific consultation related to the Eightmile Lake Storage Restoration project should begin soon thereafter. Consultation with DAHP will focus on identifying appropriate mitigation for the impact to historic structures that will be removed and replaced as part of the project. It is possible that a Memorandum of Agreement may be executed between the Corps, DAHP, IPID, and any other participating agencies or tribes. To the extent that conceptual mitigation can be developed in coordination with DAHP through the process of completing the PEIS, this could help to shorten the project-level permitting timeline identified above.

Submittal of the JARPA to the Corps would also trigger the need for the Corps to ensure the proposed project compliance with the ESA, MSA, and FWCA. This would likely require coordination with NMFS and USFWS. As noted previously, the potential impacts on fish and wildlife under the jurisdiction of these agencies are generally limited to those that could occur during construction or are otherwise expected to be largely beneficial over the long term. It is not expected that compliance would require the development of a biological assessment or formal consultation between these agencies; however, this should be confirmed at the onset. Similarly, to the extent that potentially significant impacts and conceptual mitigation are identified through the process of completing the PEIS, this could help to shorten the project-level permitting timeline identified above.

Ecology's DSO has regulatory jurisdiction over all reservoirs that impound 10 acre-feet or more of water. Replacement of the dam at Eightmile Lake will require a dam construction permit from DSO. Consultation was initiated with DSO as part of this Feasibility Study. The requirements for securing a dam safety permit were outlined in Section 3.1. DSO should be given the opportunity to review this report and consultation should continue throughout the design process to ensure that DSO requirements are met.

Compliance with the remaining permits and approvals outlined in Table 8-1 would be mostly under the jurisdiction of Chelan County. It is possible that certain permits/approvals (e.g., project-level SEPA, Shoreline Substantial Development Permit, Critical Areas Ordinance, Cleanup and Abatement Order review) may be satisfied through demonstrated compliance with other state and federal approvals discussed above. Others would still be obtained during final project design but are anticipated to be relatively straightforward (e.g., NPDES construction permit, fill and grading permits).

9 Summary and Recommendations

9.1 Summary of Proposed Improvements

IPID has relied on Eightmile Lake and the other Alpine Lakes they manage for nearly 80 years. IPID constructed control facilities on the outlet of Eightmile Lake in the 1930s to capture and store spring and early summer runoff for release in the late summer when additional flow is needed in lower Icicle Creek to maintain irrigation diversions and instream flows for fish. Eightmile Lake captures runoff from a 3,822-acre drainage basin. Due to the large size of the drainage basin relative to the storage volume in the lake, Eightmile Lake has a high potential for refill, even during dry years. Because the storage is so reliable and the lake is more accessible than the other Alpine Lakes that IPID manages, the lake is a critical piece of IPID's water supply infrastructure.

The infrastructure at Eightmile Lake is aging and will require improvement to continue to operate in a way that meets IPID's needs. The most urgent issue identified by IPID is that the low-level outlet pipe has collapsed in multiple locations, which has recently reduced the capacity of the pipeline and limits the rate at which IPID can release water to Icicle Creek. If the pipe is not replaced or repaired before the next big drought cycle, IPID will likely not be in a position to meet the irrigation water supply needs of the IPID water users. The gate that controls flow to the low-level outlet pipe also needs to be replaced. It was damaged by ice or debris and is now very difficult to open and close. In addition, the dam structure that allows IPID to store water has deteriorated. Erosion of the earthen embankment portion of the dam structure has reduced the active storage capacity available for release without pumping or siphoning to less than 1,400 acre-feet. Some storage is released via seepage. Due to these limitations, improvements are needed to restore the useable storage capacity of Eightmile Lake to 2,500 acre-feet, which is the volume allowed for storage and release by IPID's water right for the lake. Improvements are also needed to ensure efficient control and release of water stored in the lake to meet downstream water supply and instream flow needs.

This Feasibility Study identified and evaluated the following improvements for restoring the storage at Eightmile Lake and improving the control and release of water from the lake:

- Replacement of the dam with a reinforced concrete and earthen embankment structure that would have a primary spillway elevation of 4,671 feet, which would match the historical high WSEL in the lake and restore the useable storage capacity to 2,500 acre-feet.
- Construction of an embankment and secondary spillway structure in a low spot south of the existing dam to provide additional spillway capacity to meet Ecology DSO requirements.
- Replacement of the existing low-level outlet facilities with a new pipeline that would allow for greater flexibility in drawing down the lake. Flow through the new low-level outlet would be controlled by an automated valve. Telemetry would allow for remote access from IPID's office

to operate the valve and optimize releases. The low-level outlet would operate by gravity when the lake is full and transition to siphon operation as the lake is drawn down.

The primary challenge to implementing this improvement project will be determining how to construct the project at a remote location within the Alpine Lakes Wilderness. IPID has an easement agreement with the USFS that was established when the property was transferred to the USFS for management as part of the Alpine Lakes Wilderness Area. The easement agreement allows IPID to continue to have access to the site, including with mechanized equipment, to maintain the facilities and to make full use of IPID's water right. However, the site is not accessible by roads. The Alpine Lakes are often accessed by IPID by helicopter for maintenance, but even the largest helicopters have payload limitations that will make mobilization of large equipment to the site a challenge. Options that were identified are transport of a smaller excavator by large helicopter, overland transport of a larger tracked excavator, or overland transport of a spider excavator. The approach will likely be dictated by funding, the equipment available, and permit approval constraints.

Another challenge to implementing this project that is closely related to the challenge of mobilizing equipment will be the narrow window available for construction. The lake will need to be drawn down to construct the project, which typically does not happen until late in the summer. IPID might be able to facilitate early drawdown of the lake for construction, but will be constrained by weather and runoff conditions in the early summer. Construction will need to be complete before significant snowfall and consistent freezing temperatures occur. Due to the elevation of the site, snowfall and consistent freezing temperatures are likely to occur in October or early November.

The estimated implementation cost of a project that would rely on helicopters to transport and mobilize equipment to the site is approximately \$2.62 to \$2.97 million. Based on the estimated increase in useable storage that would occur (1,125 acre feet), the cost would be \$2,329 to \$2,644 per acre-foot of additional storage created.

9.2 Recommended Next Steps

Because the need to implement these improvements is critical to maintaining IPID's water supply during drought conditions, it is recommended that IPID pursue funding for detailed design of the proposed improvements and move consultation forward with the USFS to identify the best method of accessing the site for construction. Securing the appropriate permits for construction of these improvements will be critical to implementation of the project. Consequently, it is recommended that consultation specific to the Eightmile Lake Storage Restoration project proceed with the key regulatory agencies as soon as the *Icicle Strategy Programmatic Environmental Impact Statement* has been reviewed and finalized (likely late in the summer of 2017). In addition to the USFS, agencies that will require early consultation may include the DAHP, the Corps, Ecology (including DSO), WDFW, USFWS, and NMFS.

Detailed design and construction of the project will require additional field data, which would likely need to be collected in the summer or early fall, when weather conditions permit access to the site:

- **Supplemental Topographic Survey:** Additional topographic survey will be needed of the area in and around the dam and along Eightmile Creek to the downstream end of the propose low-level outlet. Some data was collected last fall, but there are still gaps in the topographic data that will need to be addressed to accurately determine where material is available, where it will be placed, and what the final design grades should be.
- **Geotechnical Review:** Work to date has only included general field observations of geology and a desk review of geologic mapping and conditions. Ecology DSO will require a geotechnical engineering report that provides recommendations for dam construction based on a detailed field investigation of geologic conditions at the site. Access to the site with equipment like a drill or backhoe, which are typically used to investigate subsurface soil conditions, will be very challenging. To satisfy DSO requirements for geotechnical review, the following is recommended:
 - Complete the field investigation and prepare a geotechnical design report prior to detailed design. The investigation would include, at a minimum, test pits (if a backhoe or excavator can be mobilized to the site) and a geophysical investigation. An exhaustive desk review of available mapping and geology reports will also be completed. If needed, additional work will be done to mobilize a remote drill for additional subsurface investigation. IPID will work with DSO to verify requirements, review data collecting, and discuss findings and recommendations for design.
 - Provide detailed field direction by a geotechnical engineer during construction. Because the ability to gather subsurface geotechnical information will be limited and subsurface conditions are likely to be variable at the site, it is recommended that supervision and field direction be provided regarding processing and placement of earth and rock materials during construction.

Based on the information reviewed and analysis of the proposed improvements, no fatal flaws have been identified that would prevent implementation of the project. However, Anchor QEA acknowledges that the project will be very challenging due to the remote location of the proposed project, regulatory constraints, and access limitations. Early consultation regarding these challenges will be key to the success of the project.

10 References

- Anchor QEA, 2015. *Appraisal Study, Eightmile Lake Storage Restoration*. Prepared for Chelan County Natural Resources Department. March 2015.
- Anchor QEA, 2017a. *Icicle Creek Water Resource Management Strategy Draft Cultural Resources Discipline Report*. Prepared for Chelan County Natural Resources Department and Washington State Department of Ecology. February 2017.
- Anchor QEA, 2017b. *Icicle Creek Water Resource Management Strategy Draft Natural Resources Discipline Report*. Prepared for Chelan County Natural Resources Department and Washington State Department of Ecology Office of the Columbia River. April 2017.
- Aspect (Aspect Consulting, LLC), 2017a. *Feasibility Study, the Alpine Lakes Optimization and Automation*. Draft. Prepared for Chelan County Natural Resources Department. Project no. 120045. May 11, 2017.
- Aspect, pending. *Icicle Strategy Programmatic Environmental Impact Statement. Prepared for Chelan County and Washington State Department of Ecology*.
- Aspect/Anchor QEA (Aspect Consulting, LLC, and Anchor QEA, LLC), 2015. *Appraisal Study, Alpine Lakes Optimization and Automation*. Prepared for Chelan County Natural Resources Department. March 20, 2015.
- Dave Horax, 2017. Verbal (telephone) communication on April 26, 2017 with David Horax of Columbia Helicopters.
- Ecology (Washington State Department of Ecology), 1992. *Dam Safety Guidelines Technical Note 2: Selection of Design/Performance Goals for Critical Design Elements*. Water Resources Program Dam Safety Office. July 1992.
- Ecology, 1993. *Dam Safety Guidelines Part IV: Dam Design and Construction*. Water Resources Program Dam Safety Office. July 1993.
- Ecology, 1995. Reconnaissance Inspection of Eightmile Lake Dam, File No: CH45-228. A letter prepared by Mel Schaefer, Jerald LaVassar, and Doug Johnson from Ecology's Dam Safety Section. December 7, 1995.
- Forsgren (Forsgren Associates, Inc.), 2014. *Draft Icicle Irrigation District Instream Flow Improvement Options Analysis Study*. Prepared for Trout Unlimited with input from Gravity Consulting, July 22, 2014.

Franklin, J.F., and C.T. Dyrness, 1973. Natural Vegetation of Oregon and Washington, United States Department of Agriculture, Forest Service, General Technical Report PNW-8.

MGS Engineering Consultants, Inc., 2007. *Dam Safety Guidelines Technical Note 1: Dam Break Inundation Analysis and Downstream Hazard Classification*. Prepared for Water Resources Program, Dam Safety Office. October 2007.

MGS Engineering Consultants, Inc., 2009. *Dam Safety Guidelines Technical Note 3: Design Storm Construction*. Prepared for Water Resources Program, Sam Safety Office. October 2009 (Revised).

DSO (Washington State Department of Ecology Dam Safety Office), 2016. Updated: Unknown. Cited: May 2017. Available from: <http://www.ecy.wa.gov/programs/wr/dams/dss.html>.

USDA NRCS (United States Department of Agriculture Natural Resources Conservation Service), 1986. Urban Hydrology for Small Watersheds. TR-55. June 1986.

USDA NRCS. Web Soil Survey. Updated: August 10, 2016. Cited: February 2017. Available from: <https://websoilsurvey.sc.egov.usda.gov/App/HomePage.htm>.

U.S. Forest Service (USFS), 2016. Alpine Lakes Wilderness Web Site. Cited: July 7, 2016. Available at: <http://www.wilderness.net/index.cfm?fuse=NWPS&sec=wildView&WID=8>.

Appendix A
Feasibility-Level Drawings

FEASIBILITY-LEVEL DESIGN

EIGHTMILE LAKE RESTORATION PROJECT

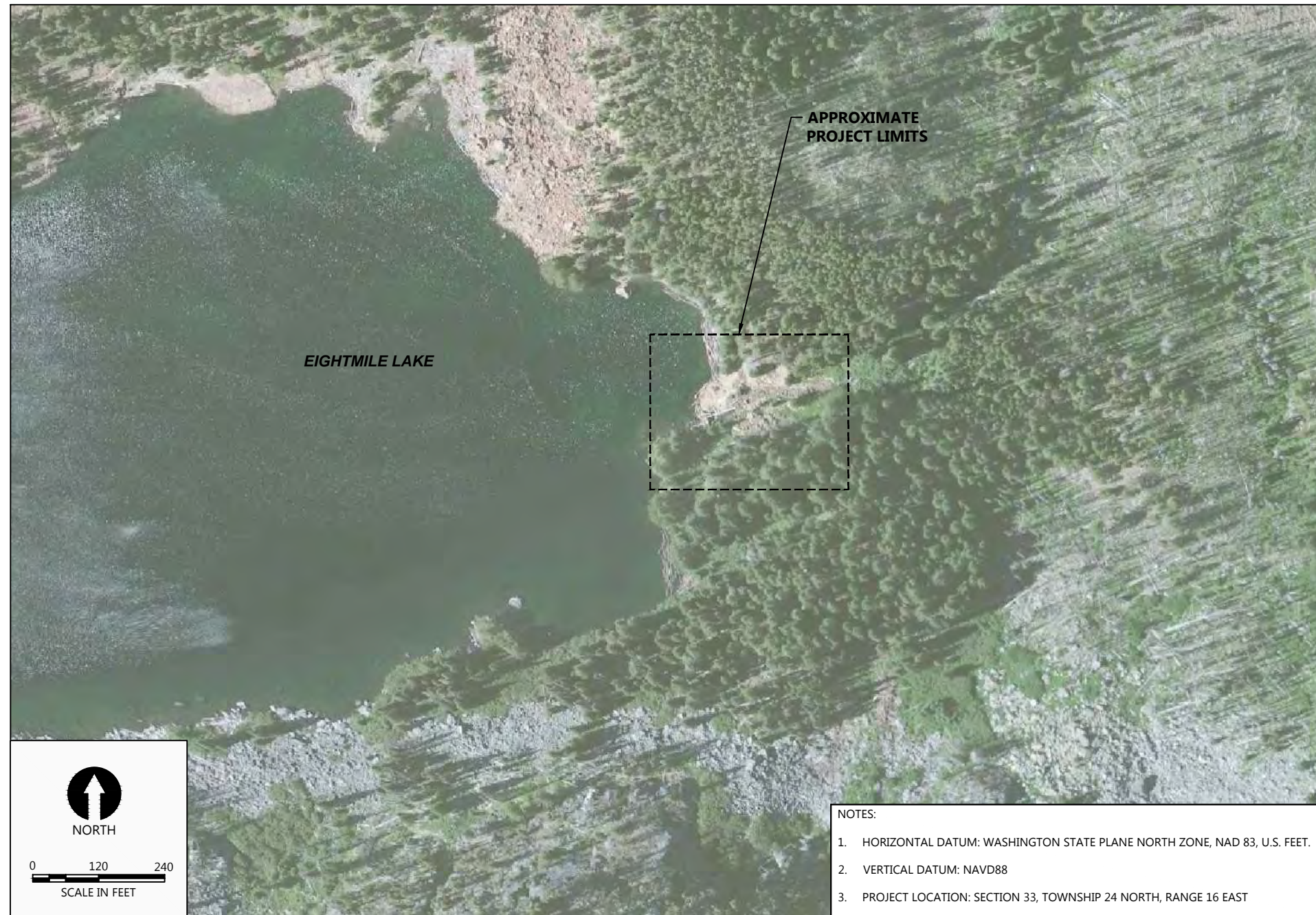

SHEET LIST		
SHEET NUMBER	SHEET	SHEET TITLE
1	G-01	COVER SHEET
2	G-02	GENERAL NOTES, LEGEND, AND ABBREVIATIONS
3	G-03	OVERALL SITE PLAN
4	G-04	EXISTING CONDITIONS PLAN
5	T-01	CONSTRUCTION ACCESS PLAN
6	D-01	DEMOLITION PLAN
7	C-01	RESTORATION PLAN
8	C-02	EMBANKMENT PLAN
9	C-03	EMBANKMENT PROFILES
10	C-04	EMBANKMENT SECTIONS (1)
11	C-05	EMBANKMENT SECTIONS (2)
12	C-06	EMBANKMENT SECTIONS (3)
13	C-07	LOW-LEVEL OUTLET PLAN
14	C-08	LOW-LEVEL OUTLET PROFILE
15	C-09	DETAILS

- NOTES:
- STRUCTURAL DESIGN DRAWINGS AND ADDITIONAL DETAIL DRAWINGS WILL BE ADDED DURING FUTURE PHASES OF DESIGN.

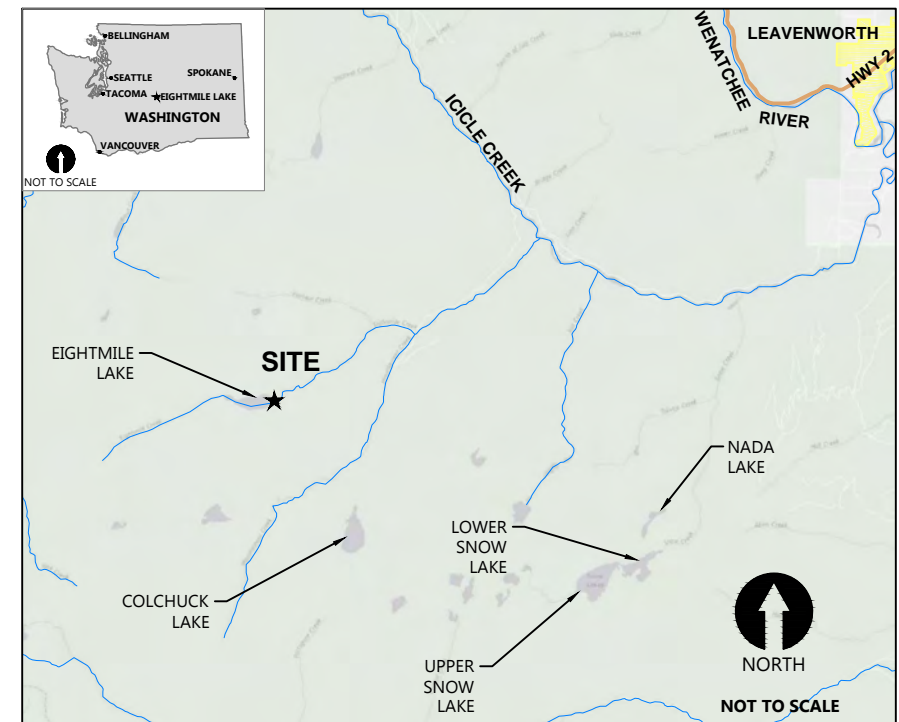

K:\Project\0204-Aspect Consulting, LLC\Ice Lake Creek Comp. Water Mgt\Eightmile Lake\Construction Plans\0204-PL-001 COVER.dwg G-01
Apr 10, 2017 7:38am drice

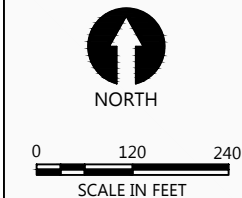

AT FULL SIZE IF NOT ONE INCH SCALE ACCORDINGLY

DRAFT



REVISIONS				
REV	DATE	BY	APP'D	DESCRIPTION

DESIGNED BY: D. RICE
 DRAWN BY: M. PRATSCHNER
 CHECKED BY: R. MONTGOMERY
 APPROVED BY: D. RICE
 SCALE: AS NOTED
 DATE: APRIL 2017

EIGHTMILE LAKE RESTORATION PROJECT

COVER SHEET

G-01

SHEET NO. 1 OF 15

- LEGEND:**
- EXISTING MAJOR CONTOUR (5' INTERVAL)
 - EXISTING MINOR CONTOUR (1' INTERVAL)
 - PROPOSED MAJOR CONTOUR (5' INTERVAL)
 - PROPOSED MINOR CONTOUR (1' INTERVAL)

PROJECT INFORMATION:
OWNER: TONY JANTZER, MANAGER
 ICICLE AND PESHASTIN IRRIGATION DISTRICT
 P.O. BOX 371
 5594 WESCOTT DRIVE
 CASHMERE, WA 98815-0371
 (509) 782-2561

ENGINEER: DAVID RICE, P.E.
 ANCHOR QEA, LLC
 750 OLIVE WAY, SUITE 1900
 SEATTLE, WA 98101
 (206) 219-5902

- SURVEY NOTES:**
1. HORIZONTAL DATUM: WASHINGTON STATE PLANE NORTH ZONE, NAD 83, U.S. FEET
 2. VERTICAL DATUM: NAVD88
 3. SOURCES OF DATA:
 - a. AERIAL PHOTOGRAPHY: ESRI BASEMAPS DATED 2016.
 - b. BATHYMETRY: GRAVITY CONSULTANTS HYDROGRAPHIC SURVEY, OCTOBER 2013
 - c. TOPOGRAPHY: GRAVITY CONSULTANTS TOPOGRAPHIC SURVEY OF THE SHORELINE, OCTOBER 2013, SUPPLEMENTED BY USGS GRID ELEVATION DATA AWAY FROM THE SHORELINE. TOPOGRAPHY WAS VERIFIED AND SUPPLEMENTED BY LIMITED DATA COLLECTED BY ANCHOR QEA ALONG THE DAM AND EMBANKMENT CREST, AT THE SHORELINE NEAR THE DAM, AND AT ALONG THE PIPELINE ALIGNMENT, OCTOBER 2016.

SYMBOLS

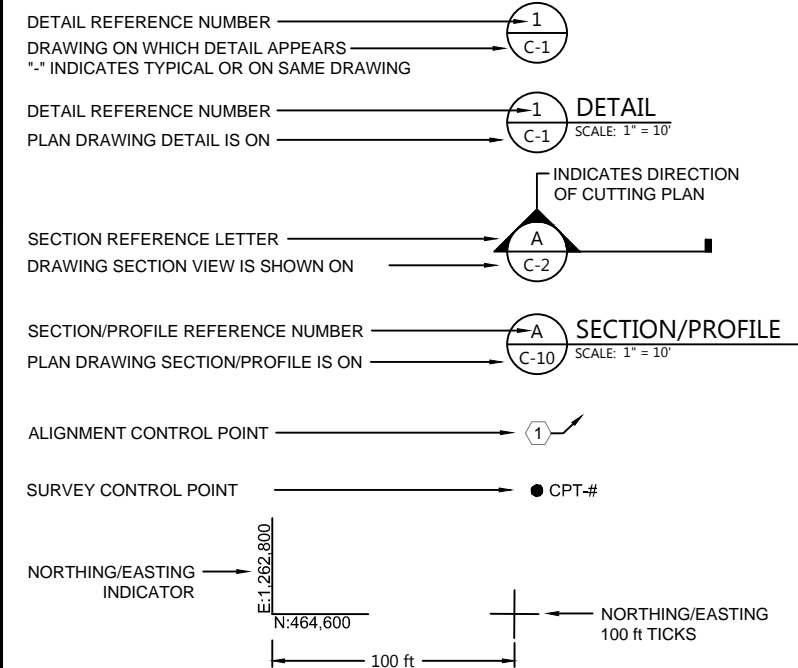

- GENERAL CONSTRUCTION NOTES:**
1. CONTRACT DOCUMENTS REFER TO THESE DRAWINGS AND THE PROJECT SPECIFICATIONS. ALL COMPONENTS OF THE CONTRACT DOCUMENTS SHALL FULLY APPLY TO THE WORK WHETHER SPECIFICALLY REFERENCED ON THE DRAWINGS OR NOT. ANY ITEMS NOT SPECIFICALLY REFERENCED IN THE NOTES ON THE DRAWINGS SHALL BE AS DESCRIBED IN THE SPECIFICATIONS.
 2. THE CONTRACTOR SHALL HAVE A COPY OF THE APPROVED CONTRACT DOCUMENTS ON THE JOBSITE AT ALL TIMES.
 3. THE CONTRACTOR SHALL FURNISH ALL MATERIALS, EQUIPMENT, AND LABOR NECESSARY TO COMPLETE ALL WORK AS INDICATED ON THE CONTRACT DOCUMENTS.
 4. A PRE-CONSTRUCTION MEETING BETWEEN THE CONTRACTOR, IPID, AND THE CONTRACTING OFFICER'S REPRESENTATIVE (COR) SHALL BE REQUIRED PRIOR TO ANY ON-SITE WORK. SEE SPECIFICATIONS FOR ADDITIONAL REQUIREMENTS.
 5. THE CONTRACTOR SHALL VISIT THE JOB SITE PRIOR TO CONSTRUCTION AND SHALL BE RESPONSIBLE FOR VERIFYING FIELD CONDITIONS AND DIMENSIONS, DEVELOPING A PLAN TO MOBILIZE EQUIPMENT AND MATERIALS NEEDED TO THE SITE TO COMPLETE THE WORK, AND CONFIRMING THAT THE WORK CAN BE ACCOMPLISHED AS SHOWN ON THESE CONTRACT DOCUMENTS. ANY DISCREPANCIES BETWEEN THE EXISTING FIELD CONDITIONS AND THE DRAWINGS OR ANY INCONSISTENCIES OR AMBIGUITIES BETWEEN THE DRAWINGS AND OTHER CONTRACT DOCUMENTS SHALL BE REPORTED IN WRITING TO THE COR PRIOR TO PROCEEDING WITH THE WORK. WORK DONE BY THE CONTRACTOR INVOLVING SUCH DISCREPANCIES WITHOUT A WRITTEN REPORT AND RESPONSE FROM THE COR SHALL BE DONE AT THE CONTRACTOR'S SOLE RISK AND EXPENSE.
 6. THE CONTRACTOR SHALL RECEIVE, IN WRITING, AUTHORIZATION TO PROCEED BEFORE STARTING WORK ON ANY ITEM NOT CLEARLY DEFINED OR IDENTIFIED BY THE CONTRACT DOCUMENTS.
 7. THE CONTRACTOR SHALL ASSUME SOLE AND COMPLETE RESPONSIBILITY FOR JOB SITE CONDITIONS DURING THE COURSE OF CONSTRUCTION, INCLUDING THE SAFETY OF ALL PERSONS AND PROPERTY. THIS REQUIREMENT SHALL APPLY CONTINUOUSLY AND IS NOT LIMITED TO NORMAL WORKING HOURS.
 8. THE CONTRACTOR SHALL BE SOLELY RESPONSIBLE FOR ALL CONSTRUCTION MEANS, METHODS, TECHNIQUES, SEQUENCES, AND PROCEDURES AND FOR COORDINATING ALL PORTIONS OF THE WORK UNDER THIS CONTRACT.
 9. THE CONTRACTOR SHALL INSTALL ALL EQUIPMENT AND MATERIALS IN ACCORDANCE WITH MANUFACTURER'S RECOMMENDATIONS UNLESS SPECIFICALLY INDICATED OTHERWISE IN THE CONTRACT DOCUMENTS, FIELD DIRECTED BY THE CONTRACTING OFFICER, OR WHERE LOCAL CODES OR REGULATIONS TAKE PRECEDENCE. ALL WORK SHALL BE IN STRICT ACCORDANCE WITH APPLICABLE PERMIT REQUIREMENTS, CODES, REGULATIONS, AND ORDINANCES.
 10. THE DETAILS PROVIDED ON THE CONTRACT DOCUMENTS ARE INTENDED TO SHOW THE FINAL RESULT OF THE DESIGN. MINOR MODIFICATIONS MAY BE REQUIRED TO SUIT JOB SITE DIMENSIONS OR CONDITIONS. SUCH MODIFICATIONS SHALL BE INCLUDED AS PART OF THE WORK.
 11. THE CONTRACTOR SHALL MAKE ALL NECESSARY PROVISIONS TO PROTECT EXISTING STRUCTURES, IMPROVEMENTS, FENCES, GATES, ROADWAYS, DRAINAGE WAYS, CULVERTS, AND VEGETATION UNTIL SUCH ITEMS ARE TO BE DISTURBED OR REMOVED AS INDICATED ON THE CONTRACT DOCUMENTS. IF SUCH ITEMS ARE DAMAGED OR NEED TO BE REMOVED OR MODIFIED TO FACILITATE CONSTRUCTION, THE CONTRACTOR SHALL FIRST NOTIFY THE COR AND THEN REPLACE OR REPAIR THE ITEMS TO EQUAL OR BETTER CONDITION AT THE CONTRACTOR'S EXPENSE AND TO THE SATISFACTION OF THE COR.
 12. THE CONTRACTOR SHALL KEEP THE JOB SITE AREA CLEAN AND FREE FROM HAZARDS. THE CONTRACTOR SHALL DISPOSE OF ALL DIRT, DEBRIS, AND RUBBISH FOR THE DURATION OF THE WORK. UPON COMPLETION, THE CONTRACTOR SHALL REMOVE ALL MATERIAL AND EQUIPMENT NOT SPECIFIED TO REMAIN ON THE PROPERTY. SEE THE SPECIFICATIONS FOR ADDITIONAL REQUIREMENTS.
 13. REPRESENTATIONS OF TRUE NORTH SHALL NOT BE USED TO IDENTIFY OR ESTABLISH THE BEARING OF TRUE NORTH AT THE JOB SITE.
 14. WHERE A CONSTRUCTION DETAIL IS NOT SHOWN OR NOTED, THE DETAIL SHALL BE THE SAME AS FOR OTHER SIMILAR WORK.

- GENERAL CONSTRUCTION NOTES: (CONTINUED)**
15. THE NOTES, DETAILS AND SPECIFICATIONS ON THE CONTRACT DOCUMENTS SHALL TAKE PRECEDENCE OVER THESE GENERAL NOTES.
 16. DIMENSION CALL-OUTS SHALL TAKE PRECEDENCE OVER SCALES SHOWN ON THE CONTRACT DOCUMENTS.
 17. STATIONING, DISTANCES, AND LENGTHS SHOWN ON THE DRAWINGS ARE BASED ON HORIZONTAL MEASUREMENTS.
 18. THE CONTRACTOR SHALL BE REQUIRED TO CONTROL ON-SITE STORM WATER RUNOFF BY USING TEMPORARY OR PERMANENT DRAINAGE EROSION/SILTATION CONTROL PROCEDURES, AS INDICATED ON THE CONTRACT DOCUMENTS.
 19. THE CONTRACTOR SHALL MAINTAIN HAND DRAWN REDLINES, FIELD NOTES AND PHOTOGRAPHS ("FIELD DOCUMENTATION") OF ALL IMPROVEMENTS AS THE WORK PROGRESSES. THE CONTRACTOR SHALL ALSO TAKE PHOTOGRAPHS AND VIDEO TO DOCUMENT CONDITIONS PRIOR TO CONSTRUCTION. THE CONTRACTOR'S FIELD DOCUMENTATION SHALL BE MAINTAINED ON SITE AND SHALL BE AVAILABLE FOR REVIEW BY THE CONTRACTING OFFICER AT ALL TIMES. THE CONTRACTOR SHALL PROVIDE FIELD DOCUMENTATION TO THE COR FOR THE PREPARATION OF CERTIFIED RECORD DRAWINGS PRIOR TO PROJECT ACCEPTANCE.

- GENERAL CIVIL CONSTRUCTION NOTES:**
1. ALL SITE WORK SHALL BE AS INDICATED ON THE CONTRACT DOCUMENTS. DO NOT EXCAVATE AND DISTURB BEYOND THE CLEARING LIMITS SHOWN ON THE CONTRACT DOCUMENTS UNLESS OTHERWISE APPROVED BY THE COR.
 2. DEBRIS AND GARBAGE SHALL BE REMOVED FROM THE JOB SITE AND DISPOSED OF LEGALLY, AS REQUIRED BY THE PROJECT SPECIFICATIONS.
 3. THE AREAS OF THE JOB SITE DISTURBED BY THE WORK SHALL BE GRADED SMOOTH AND PROTECTED AND/OR REVEGETATED AS SPECIFIED HEREIN.
 4. PIPE MATERIALS SHALL BE AS INDICATED ON THE CONTRACT DOCUMENTS.
 5. ALL EQUIPMENT AND MATERIALS NOT INDICATED ON THE DRAWINGS TO COME FROM THE SITE SHALL BE NEW AND UNDAMAGED, UNLESS OTHERWISE APPROVED BY THE COR AND THE ENGINEER. THE SAME MANUFACTURER OF EACH ITEM SHALL BE USED THROUGHOUT THE WORK UNLESS OTHERWISE APPROVED BY THE COR AND THE ENGINEER.

ABBREVIATIONS:

ABB	TERM
AASHTO	AMERICAN ASSOCIATION OF STATE HIGHWAY AND TRANSPORTATION OFFICIALS
ABB	TERM
ABB	ABBREVIATION
APPROX	APPROXIMATE
ASSY	ASSEMBLY
ASTM	AMERICAN SOCIETY FOR TESTING AND MATERIALS
BM	BENCH MARK
CFS	CUBIC FEET PER SECOND
CL	CENTERLINE
CMP	CORRUGATED METAL PIPE
CONC	CONCRETE
CONT	CONTINUED OR CONTINUOUS
CP	CONTROL POINT (AS IN SURVEY)
CPE	CORRUGATED POLYETHYLENE
CSBC	CRUSHED SURFACING BASE COURSE
CSTC	CRUSHED SURFACING TOP COURSE
*	DEGREES
DIA	DIAMETER
E	EAST, EASTING
EA	EACH
ELE	ELEVATION
EX	EXISTING
FG	FINISHED GRADE
FT	FOOT OR FEET
GALV	GALVANIZED
GPM	GALLONS PER MINUTE
HDPE	HIGH-DENSITY POLYETHYLENE
ID	INSIDE DIAMETER
IE	INVERT ELEVATION
IN	INCH OR INCHES
IPID	ICICLE AND PESHASTIN IRRIGATION DISTRICTS
MAX	MAXIMUM
MIN	MINIMUM
N	NORTH, NORTHING
OC	ON CENTER
OD	OUTSIDE DIAMETER
PE	PROFESSIONAL ENGINEER
QTY	QUANTITY
R	RADIUS
S	SLOPE
SF	SQUARE FOOT OR FEET
SPEC	SPECIFICATION
STA	STATION
SY	SQUARE YARD
TOW	TOP OF WALL
TYP	TYPICAL
W	WEST
WSDOT	WASHINGTON STATE DEPARTMENT OF TRANSPORTATION
WSEL	WATER SURFACE ELEVATION
YR	YEAR

Apr 10, 2017 7:40am drice K:\Project\0204-Aspect Consulting, L.L.C.\Eightmile Lake\Construction Plans\0204-PL-002 NOTES.dwg G-02

DRAFT

AT FULL SIZE IF NOT ONE INCH SCALE ACCORDINGLY



REVISIONS				
REV	DATE	BY	APP'D	DESCRIPTION

DESIGNED BY: D. RICE
 DRAWN BY: M. PRATSCHNER
 CHECKED BY: R. MONTGOMERY
 APPROVED BY: D. RICE
 SCALE: AS NOTED
 DATE: APRIL 2017

EIGHTMILE LAKE RESTORATION PROJECT

GENERAL NOTES, LEGEND, AND ABBREVIATIONS

G-02

SHEET NO. 2 OF 15

K:\Project\102004-Aspect Consulting, L.L.C.\Eightmile Lake\Construction Plans\0204-PL-003 SITE.dwg G-03
Apr 10, 2017 7:42am drice



LEGEND:
 —4570— MAJOR CONTOUR (10')
 ——— MINOR CONTOUR (2')



- NOTES:
1. HORIZONTAL DATUM: WASHINGTON STATE PLANE NORTH ZONE, NAD 83, U.S. FEET.
 2. VERTICAL DATUM: NAVD88
 3. FOR ADDITIONAL SURVEY NOTES, SEE DWG. G-02.
 4. AERIAL PHOTOGRAPHY: ESRI BASE MAPS, 2015.

AT FULL SIZE IF NOT ONE INCH SCALE ACCORDINGLY

DRAFT



REVISIONS				
REV	DATE	BY	APP'D	DESCRIPTION

DESIGNED BY: D. RICE
 DRAWN BY: M. PRATSCHNER
 CHECKED BY: R. MONTGOMERY
 APPROVED BY: D. RICE
 SCALE: AS NOTED
 DATE: APRIL 2017

EIGHTMILE LAKE RESTORATION PROJECT

OVERALL SITE PLAN

G-03

K:\Project\0204-Aspect Consulting, L.L.C.\Cedar Creek Comp. Water Mgt\Eightmile Lake\Construction Plans\0204-PL-004 EXIST.dwg, G-04
Apr 10, 2017 7:45am drice

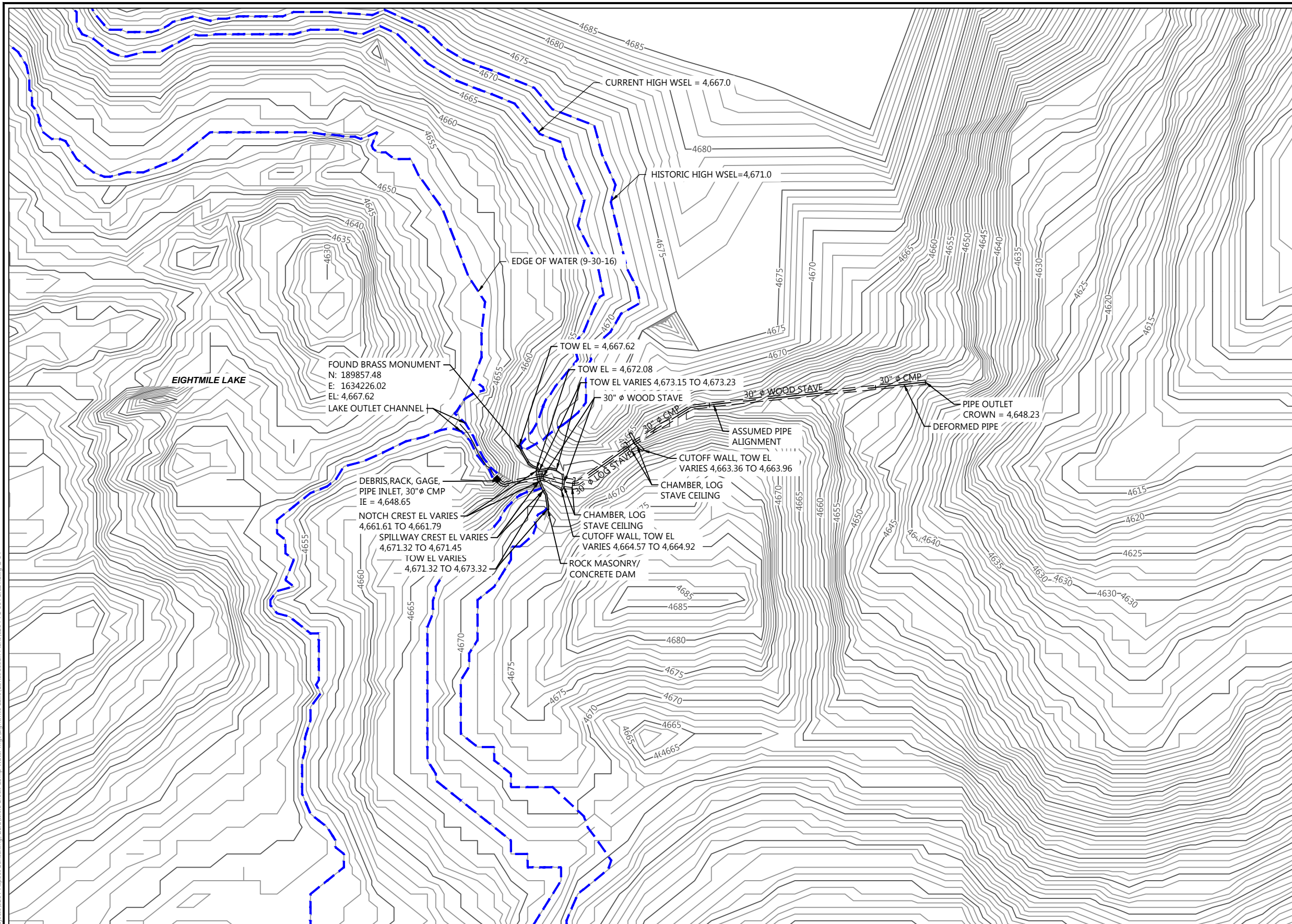

- LEGEND:
- 4570— MAJOR CONTOUR (10')
 - MINOR CONTOUR (2')
 - == == EXISTING PIPE (BURIED)
 - - - - EDGE OF WATER



- NOTES:
1. HORIZONTAL DATUM: WASHINGTON STATE PLANE NORTH ZONE, NAD 83, U.S. FEET.
 2. VERTICAL DATUM: NAVD88
 3. FOR ADDITIONAL SURVEY NOTES, SEE DWG. G-02.

AT FULL SIZE IF NOT ONE INCH SCALE ACCORDINGLY

DRAFT



REVISIONS				
REV	DATE	BY	APP'D	DESCRIPTION

DESIGNED BY: D. RICE
 DRAWN BY: M. PRATSCHNER
 CHECKED BY: R. MONTGOMERY
 APPROVED BY: D. RICE
 SCALE: AS NOTED
 DATE: APRIL 2017

EIGHTMILE LAKE RESTORATION PROJECT

EXISTING CONDITIONS

G-04

SHEET NO. 4 OF 15

K:\Project\0204-Aspect Consulting, LLC\Icicle Creek Comp. Water Mgt\Eightmile Lake\Construction Plans\0204-PL-005 ACCESS.dwg T-01
Apr 10, 2017 7:48am drice

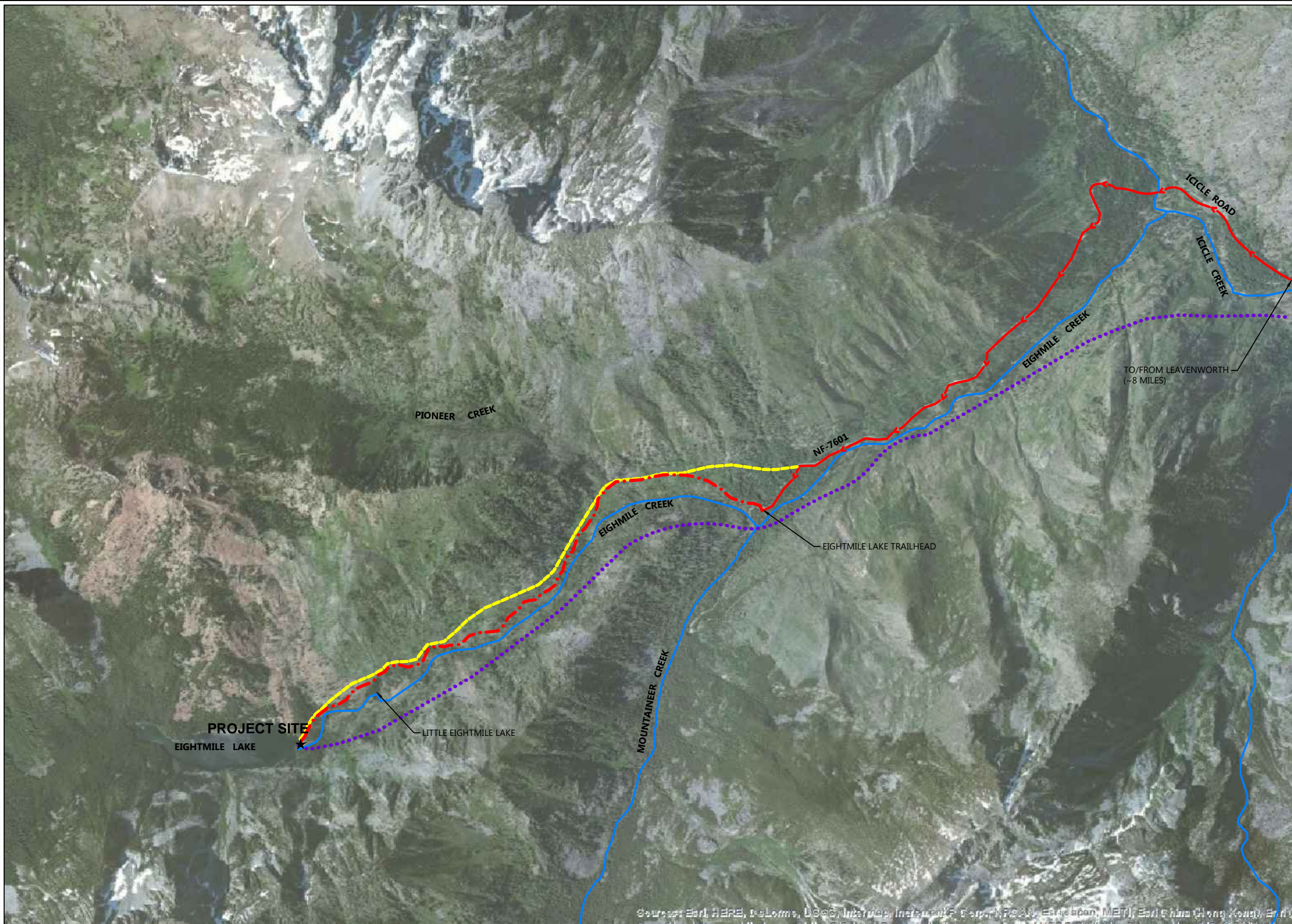

- LEGEND:
- CREEK
 - VEHICULAR ACCESS
 - . - . FOOT ACCESS
 - EXCAVATOR ACCESS (IF PERMITTED)
 - HELICOPTER ACCESS

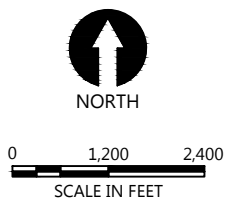

- NOTES:
1. HORIZONTAL DATUM: WASHINGTON STATE PLANE NORTH ZONE, NAD 83, U.S. FEET.
 2. VERTICAL DATUM: NAVD88
 3. FOR ADDITIONAL SURVEY NOTES, SEE DWG. G-02.

AT FULL SIZE IF NOT ONE INCH SCALE ACCORDINGLY

© 2017 Esri, HERE, DeLorme, USGS, Intermap, Incorporeo, P. Sw., NPSAN, Esri Japan, MBT, Esri China (Hong Kong), Swi

DRAFT



REVISIONS				
REV	DATE	BY	APP'D	DESCRIPTION

DESIGNED BY: D. RICE
 DRAWN BY: M. PRATSCHNER
 CHECKED BY: R. MONTGOMERY
 APPROVED BY: D. RICE
 SCALE: AS NOTED
 DATE: APRIL 2017

EIGHTMILE LAKE RESTORATION PROJECT

CONSTRUCTION ACCESS PLAN

T-01

SHEET NO. 5 OF 15

K:\Projects\2004-Aspect Consulting, L.L.C.\Idle Creek Comp. Water, MtEightmile Lake\Construction Plans\0204-PL-016 DEMO.dwg, D:01
 Jun 02 2017 5:57am drice

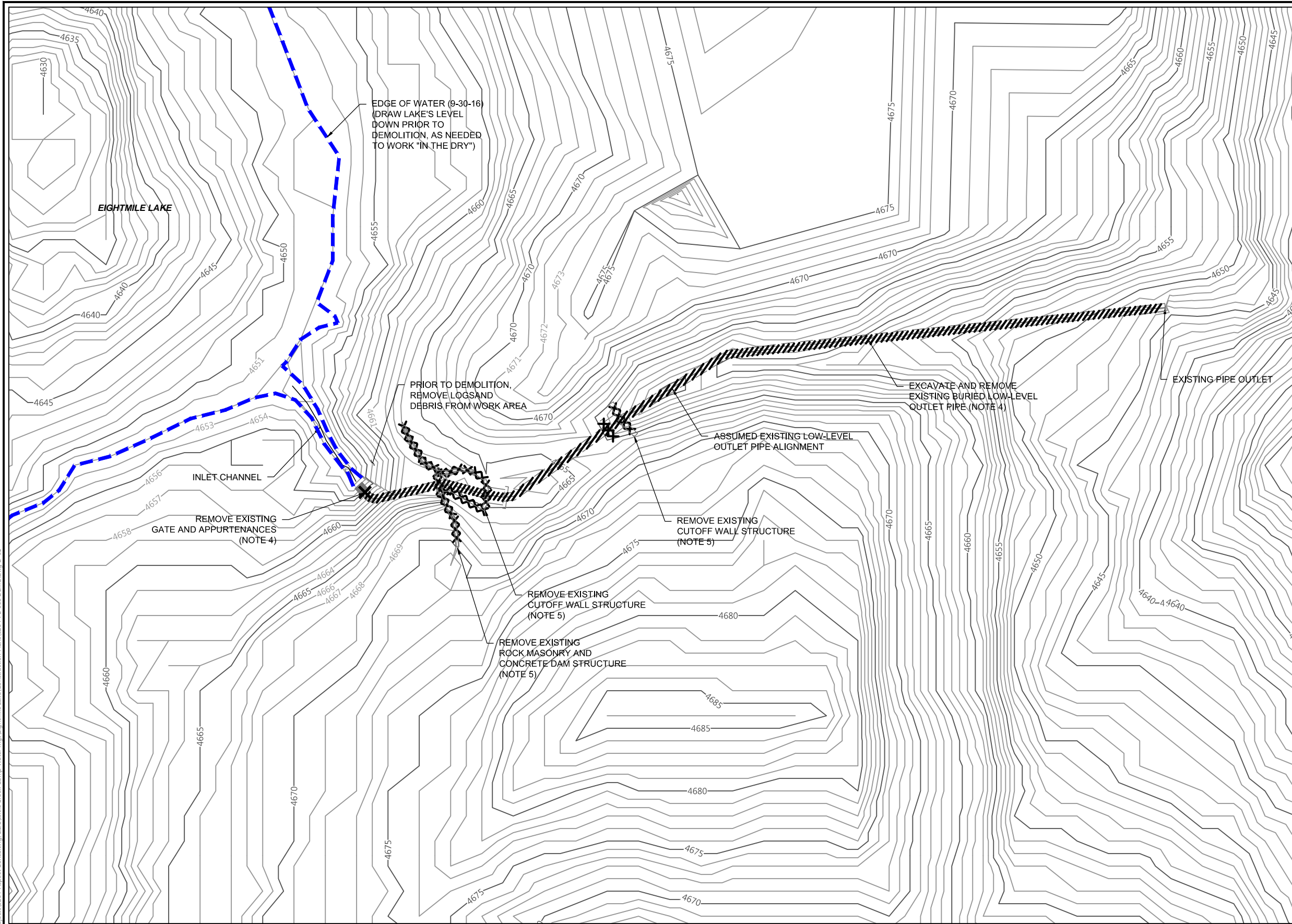

LEGEND:

- 4570— MAJOR CONTOUR (10')
- MINOR CONTOUR (2')
- //// REMOVE PIPE
- XXXX REMOVE STRUCTURE
- X REMOVE EQUIPMENT

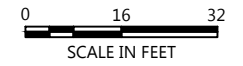

NOTES:

1. HORIZONTAL DATUM: WASHINGTON STATE PLANE NORTH ZONE, NAD 83, U.S. FEET.
2. VERTICAL DATUM: NAVD88
3. FOR ADDITIONAL SURVEY NOTES, SEE DWG. G-02.
4. PIPE, GATE, AND OTHER EQUIPMENT SHALL BE FULLY REMOVED, HAULED FROM THE SITE BY HELICOPTER OR OTHER APPROVED METHOD, AND DISPOSED OF AS REQUIRED BY SPECIFICATIONS.
5. EXISTING ROCK MASONRY AND CONCRETE STRUCTURES SHALL BE BROKEN DOWN, STOCKPILED, AND REUSED, IF POSSIBLE, AS PART OF NEW DAM AND SPILLWAY CONSTRUCTION. IF NOT REUSED, CONCRETE AND REINFORCEMENT SHALL BE HAULED FROM THE SITE BY HELICOPTER AND DISPOSED OF, AS REQUIRED BY THE SPECIFICATIONS.

DRAFT

AT FULL SIZE IF NOT ONE INCH SCALE ACCORDINGLY



REVISIONS					
REV	DATE	BY	APP'D	DESCRIPTION	

DESIGNED BY: D. RICE
 DRAWN BY: M. PRATTSCHNER
 CHECKED BY: R. MONTGOMERY
 APPROVED BY: D. RICE
 SCALE: AS NOTED
 DATE: APRIL 2017

EIGHTMILE LAKE RESTORATION PROJECT

DEMOLITION PLAN

D-01

K:\Projects\0204-Aspect Consulting, L.L.C\Eightmile Lake\Construction Plans\0204-PL-007 RESTORATION.dwg C-01
May 29, 2017 10:02am drice

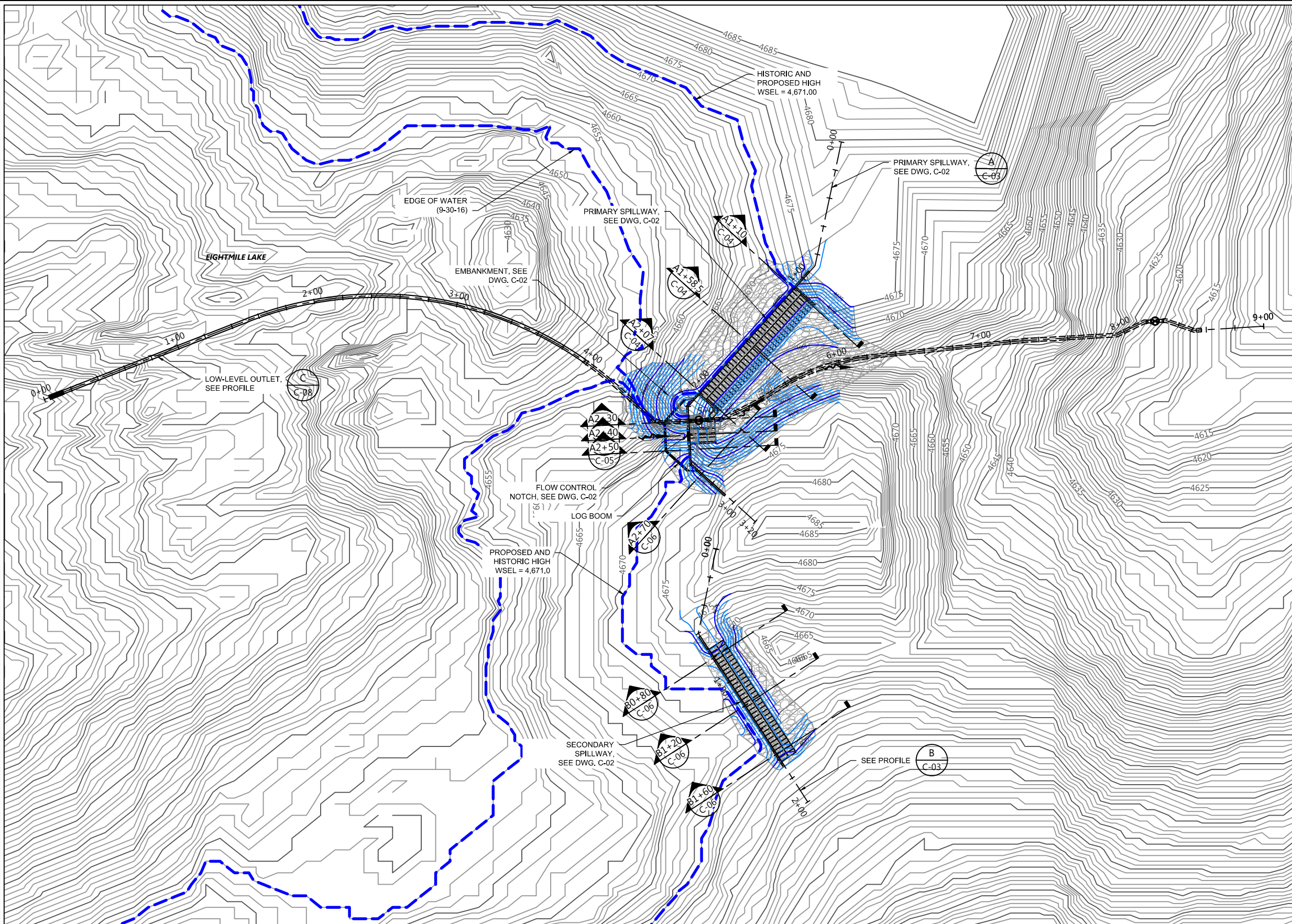

- LEGEND:**
- 4570— EXISTING MAJOR CONTOUR (5')
 - EXISTING MINOR CONTOUR (1')
 - MAJOR CONTOUR (5' INTERVAL)
 - MINOR CONTOUR (1' INTERVAL)
 - SLOPE ARMORING
 - SPILLWAY GABIONS W/CONCRETE
 - REINFORCED CONCRETE WALL
 - DIRECTION OF SURFACE SLOPE

INDICATES DIRECTION OF CUTTING PLAN

SECTION "A" IS SHOWN ON DRAWING "C-02"



- NOTES:**
- HORIZONTAL DATUM: WASHINGTON STATE PLANE NORTH ZONE, NAD 83, U.S. FEET.
 - VERTICAL DATUM: NAVD88
 - FOR DETAILED EMBANKMENT PLAN, SEE DWG C-02.
 - FOR DETAILED LOW-LEVEL OUTLET PLAN, SEE DWG C-07.

AT FULL SIZE IF NOT ONE INCH SCALE ACCORDINGLY

DRAFT



REVISIONS				
REV	DATE	BY	APP'D	DESCRIPTION

DESIGNED BY: D. RICE
 DRAWN BY: M. PRATSCHNER
 CHECKED BY: R. MONTGOMERY
 APPROVED BY: D. RICE
 SCALE: AS NOTED
 DATE: APRIL 2017

EIGHTMILE LAKE RESTORATION PROJECT

RESTORATION PLAN

C-01

SHEET NO. 7 OF 15

May 29, 2017 9:43am office
 C:\Projects\0204_Aspinet Consulting, LLC\Fido Creek Comp Water Mgmt\Eightmile Lake\Construction Plans\0204_PL-008 EMBANKMENT SPILL WSECC.dwg, C-02

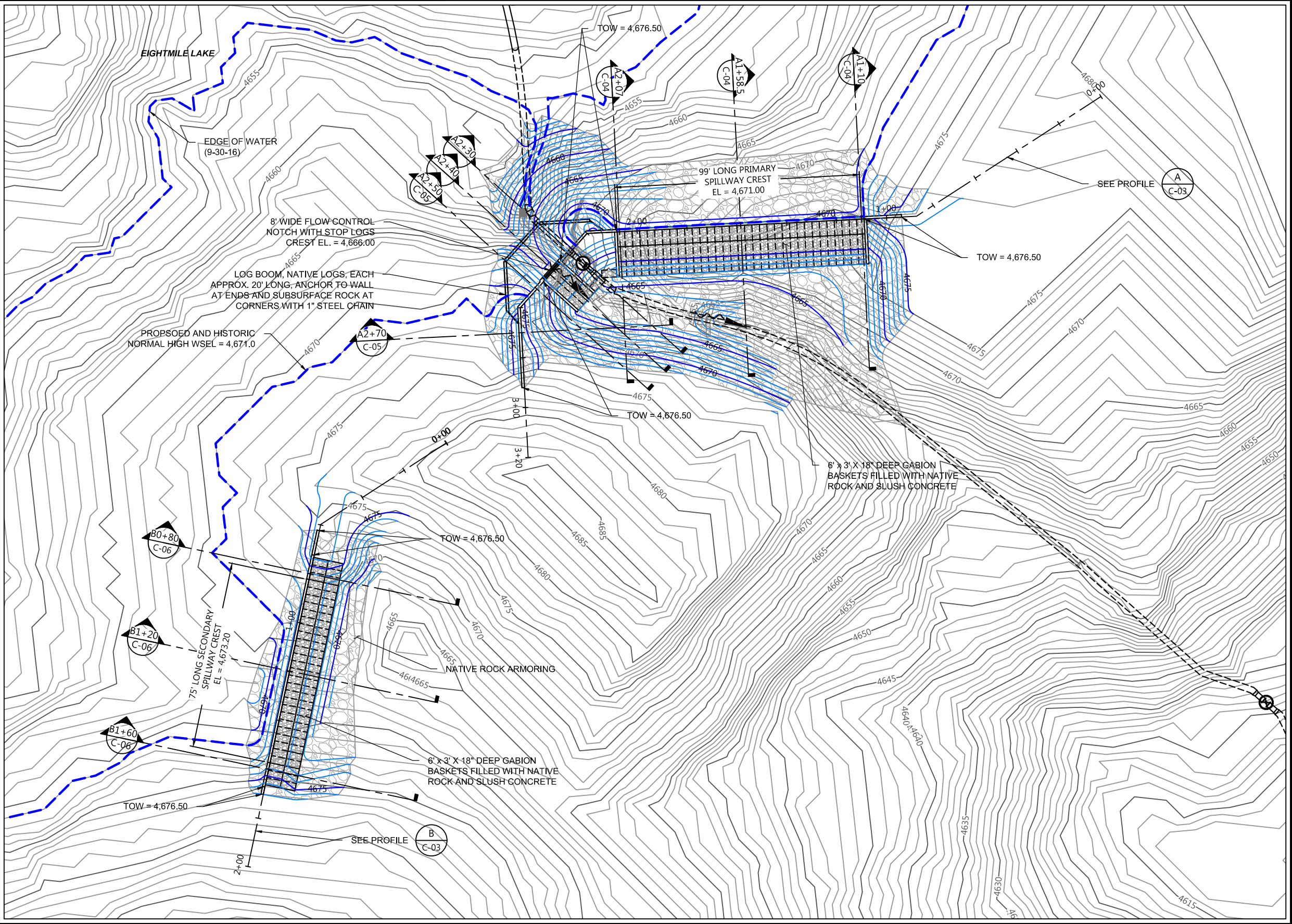

- LEGEND:
- 4570 — EXISTING MAJOR CONTOUR (5')
 - — — EXISTING MINOR CONTOUR (1')
 - — — MAJOR CONTOUR (5' INTERVAL)
 - — — MINOR CONTOUR (1' INTERVAL)
 - SLOPE ARMORING
 - SPILLWAY GABIONS W/CONCRETE
 - REINFORCED CONCRETE WALL
 - DIRECTION OF SURFACE FLOW

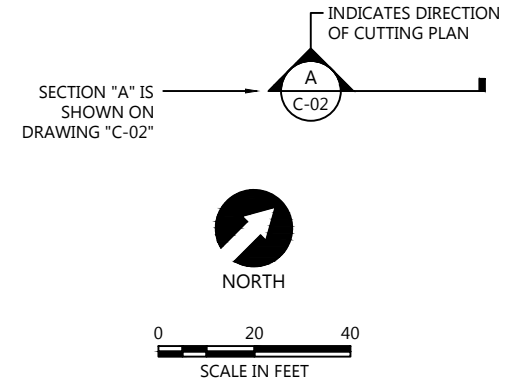

- NOTES:
- HORIZONTAL DATUM: WASHINGTON STATE PLANE NORTH ZONE, NAD 83, U.S. FEET.
 - VERTICAL DATUM: NAVD88

AT FULL SIZE IF NOT ONE INCH SCALE ACCORDINGLY

DRAFT



REVISIONS				
REV	DATE	BY	APP'D	DESCRIPTION

DESIGNED BY: D. RICE
 DRAWN BY: M. PRATSCNER
 CHECKED BY: R. MONTGOMERY
 APPROVED BY: D. RICE
 SCALE: AS NOTED
 DATE: APRIL 2017

EIGHTMILE LAKE RESTORATION PROJECT

EMBANKMENT PLAN

C-02

SHEET NO. 8 OF 15

May 29, 2017 9:48am office C:\Projects\0204_Aspex Consulting, L.L.C.\Lake Creek Comp. Water Mgmt\Eightmile Lake\Construction Plans\0204_PL-008 EMBANKMENT SPILL LSECC.dwg C-03

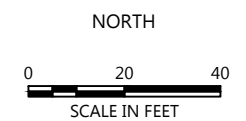
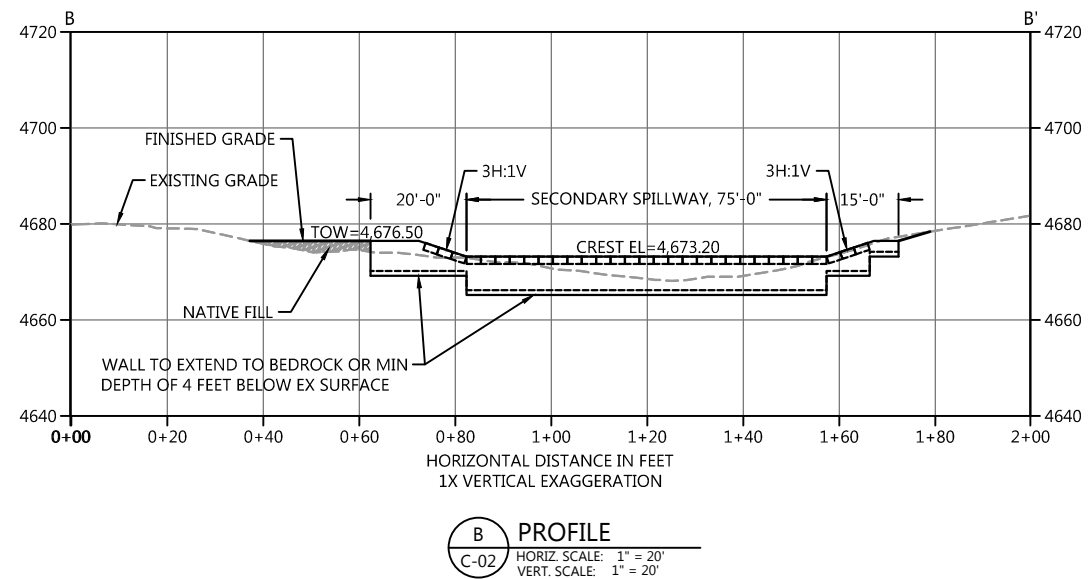
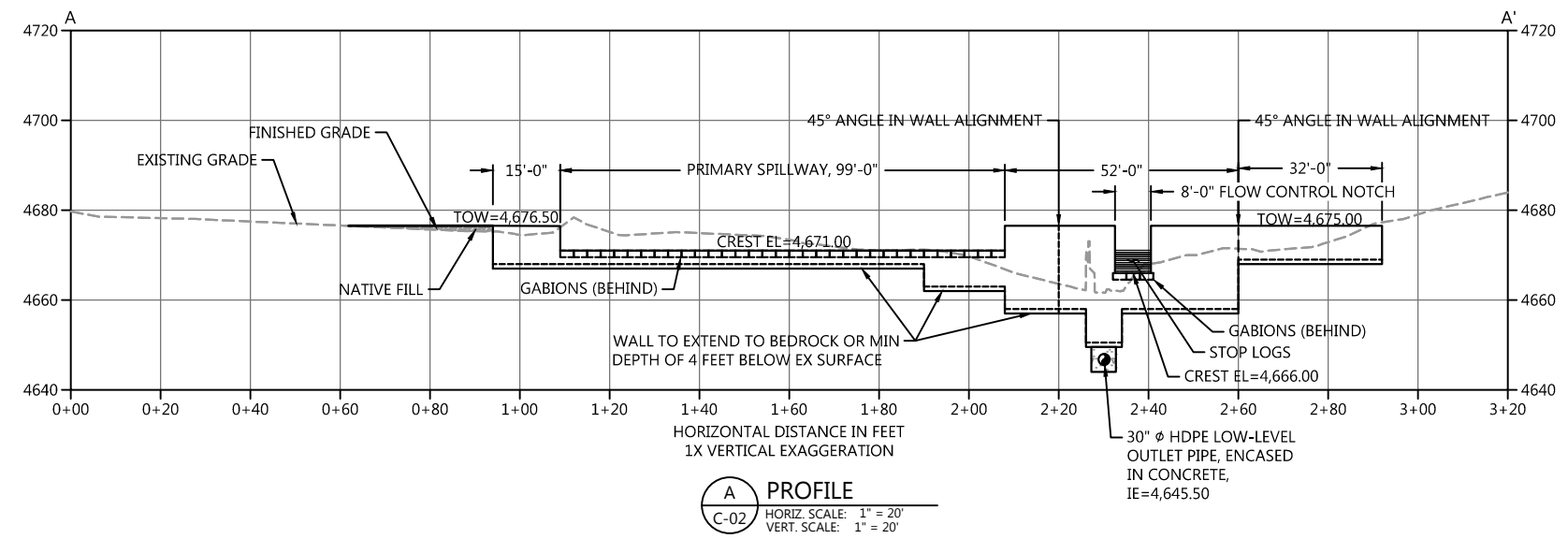

- NOTES:
1. HORIZONTAL DATUM: WASHINGTON STATE PLANE NORTH ZONE, NAD 83, U.S. FEET.
 2. VERTICAL DATUM: NAVD88

AT FULL SIZE IF NOT ONE INCH SCALE ACCORDINGLY

DRAFT



REVISIONS				
REV	DATE	BY	APP'D	DESCRIPTION

DESIGNED BY: D. RICE
 DRAWN BY: M. PRATSCHNER
 CHECKED BY: R. MONTGOMERY
 APPROVED BY: D. RICE
 SCALE: AS NOTED
 DATE: APRIL 2017

EIGHTMILE LAKE RESTORATION PROJECT

EMBANKMENT PROFILES

C-03

SHEET NO. 9 OF 15

K:\Projects\0204-Aspect Consulting, LLC\Eightmile Lake Construction Plans\0204-PL-008 EMBANKMENT STILL XSSECTION C-04
 May 29, 2017 10:23am drice

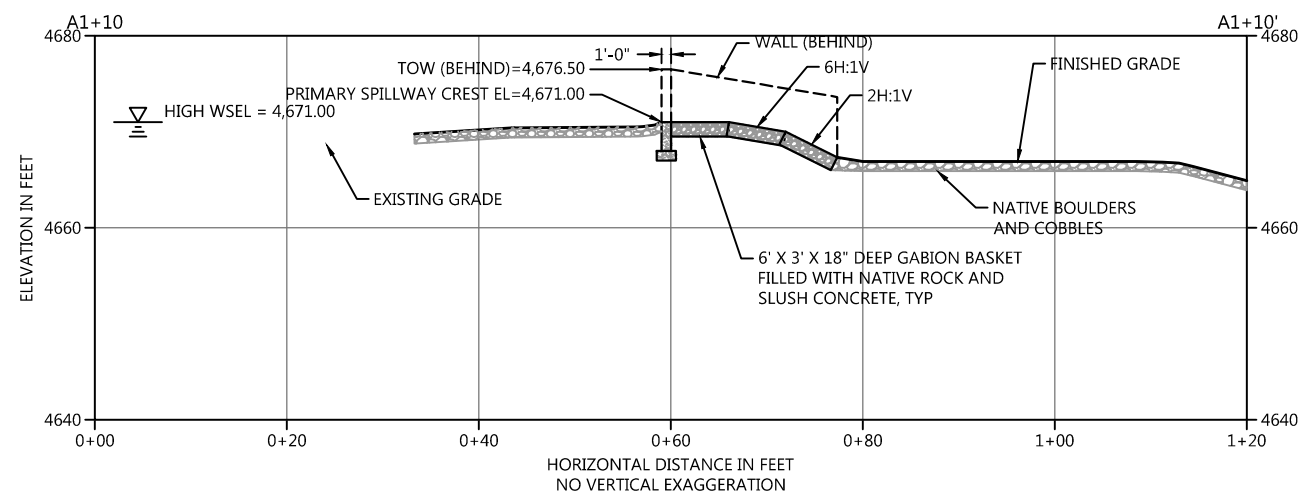

A1+10 SECTION
 C-2
 HORIZ. SCALE: 1" = 10'
 VERT. SCALE: 1" = 10'

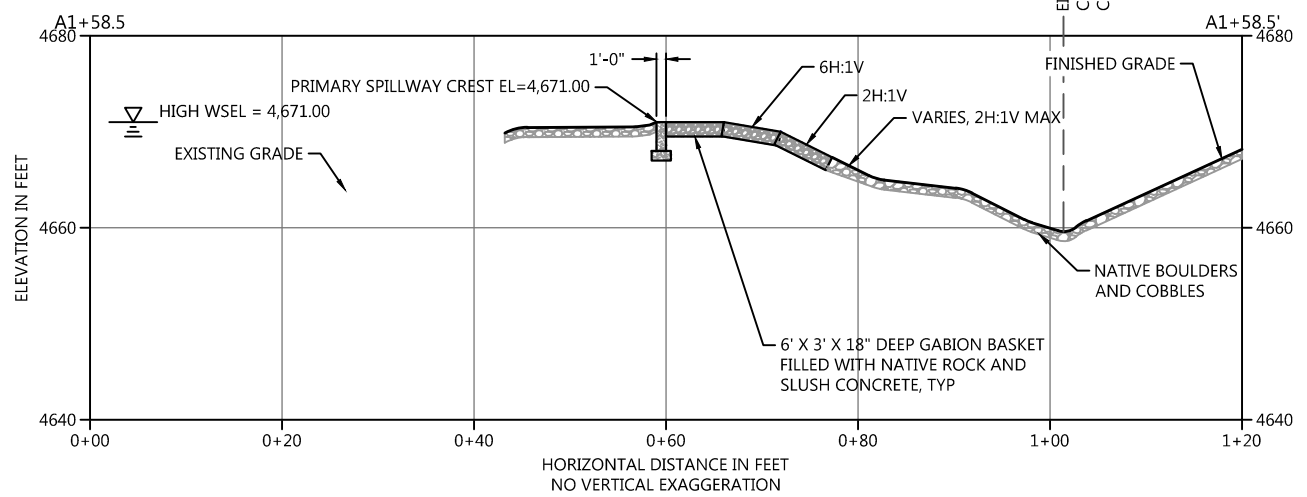

A1+58.5 SECTION
 C-2
 HORIZ. SCALE: 1" = 10'
 VERT. SCALE: 1" = 10'

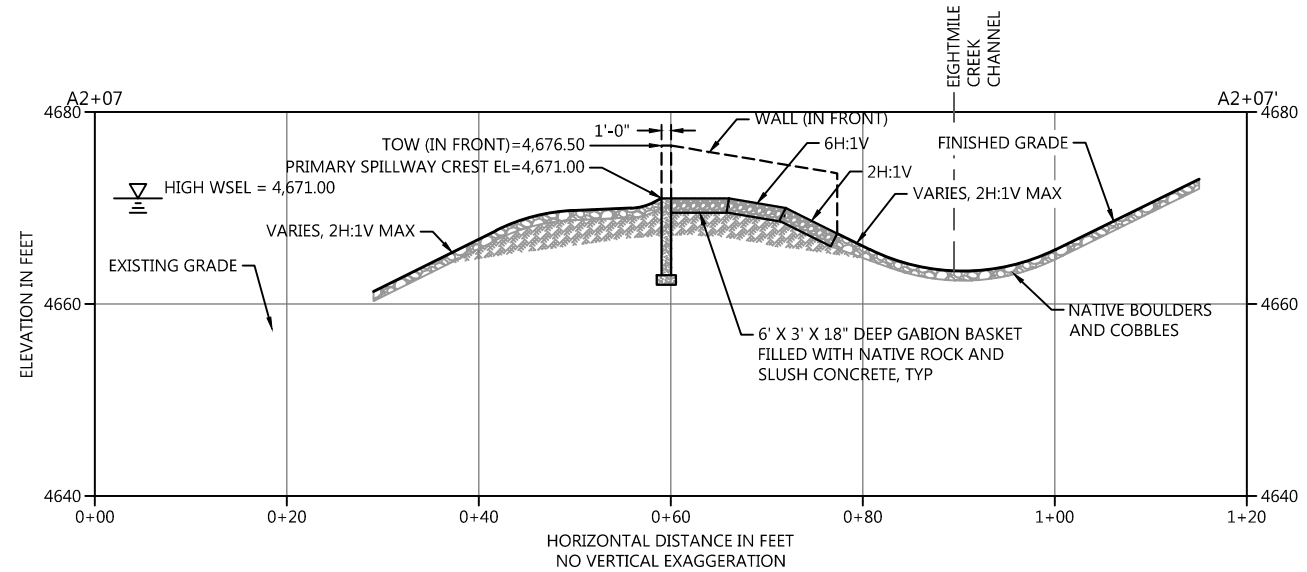

A2+07 SECTION
 C-2
 HORIZ. SCALE: 1" = 10'
 VERT. SCALE: 1" = 10'

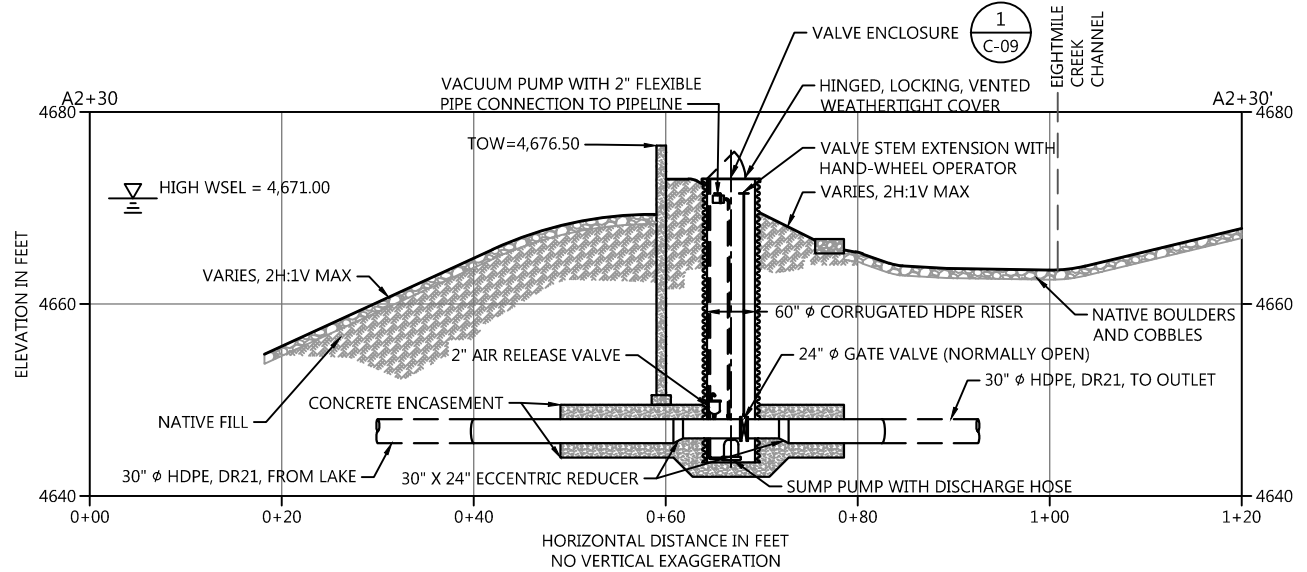

A2+30 SECTION
 C-2
 HORIZ. SCALE: 1" = 10'
 VERT. SCALE: 1" = 10'

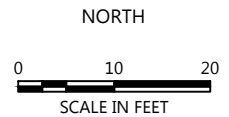

- NOTES:
- HORIZONTAL DATUM: WASHINGTON STATE PLANE NORTH ZONE, NAD 83, U.S. FEET.
 - VERTICAL DATUM: NAVD88

DRAFT



REVISIONS				
REV	DATE	BY	APP'D	DESCRIPTION

DESIGNED BY: D. RICE
 DRAWN BY: M. PRATSCHNER
 CHECKED BY: R. MONTGOMERY
 APPROVED BY: D. RICE
 SCALE: AS NOTED
 DATE: APRIL 2017

EIGHTMILE LAKE RESTORATION PROJECT

EMBANKMENT SECTIONS (1)

C-04

SHEET NO. 10 OF 15

AT FULL SIZE IF NOT ONE INCH SCALE ACCORDINGLY

C:\Projects\0204_Aspex Consulting, L.L.C.\Eightmile Lake Construction Plans\0204_PL-008 EMBANKMENT SPILL WSEC.dwg, C-05
 May 29, 2017 9:53am dfrce

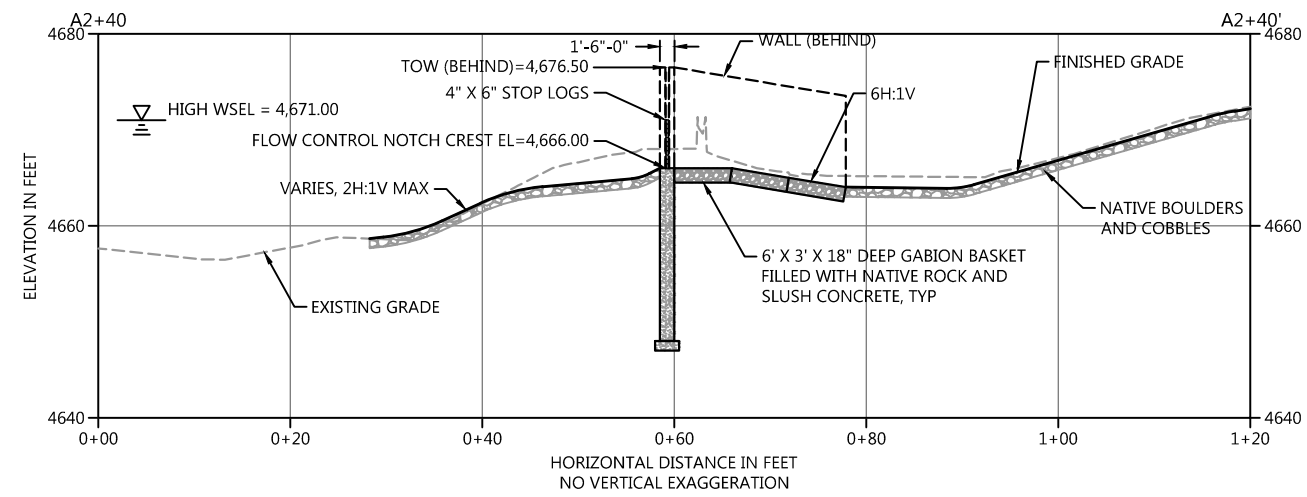

A2+40 SECTION
 C-2
 HORIZ. SCALE: 1" = 10'
 VERT. SCALE: 1" = 10'

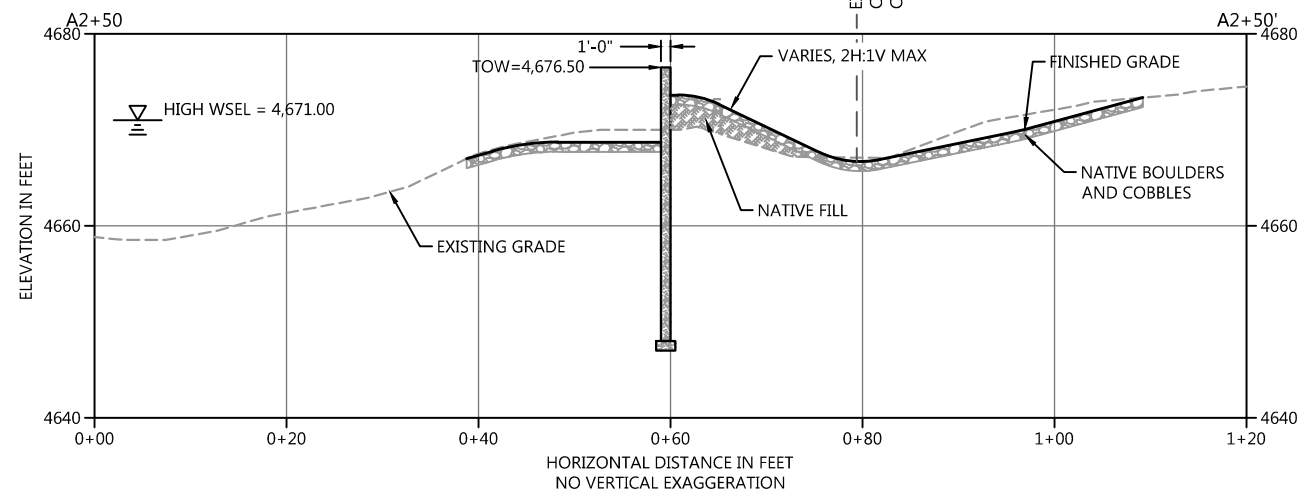

A2+50 SECTION
 C-2
 HORIZ. SCALE: 1" = 10'
 VERT. SCALE: 1" = 10'

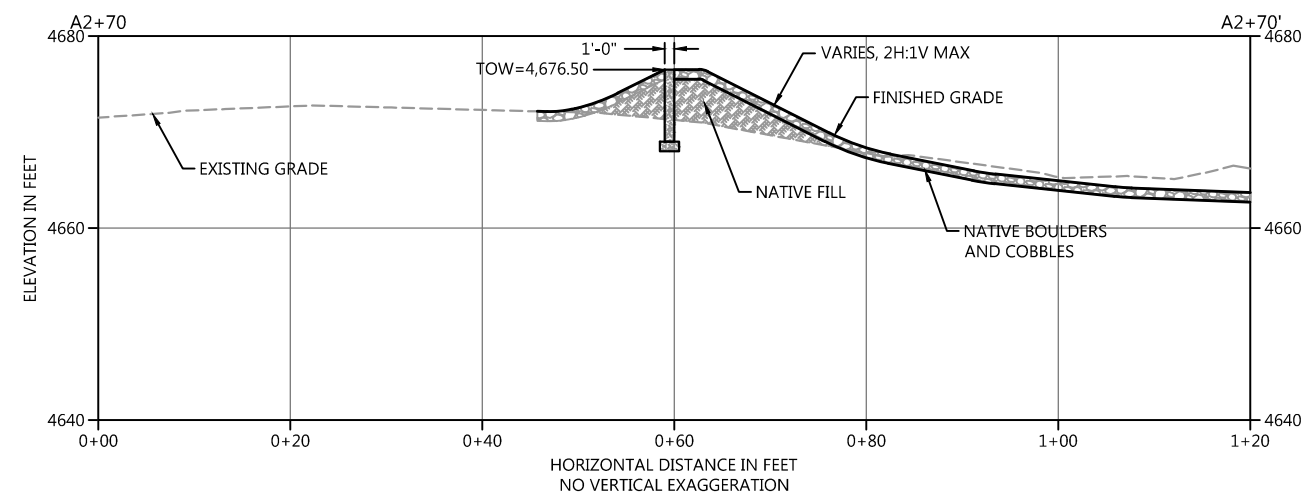

A2+70 SECTION
 C-2
 HORIZ. SCALE: 1" = 10'
 VERT. SCALE: 1" = 10'

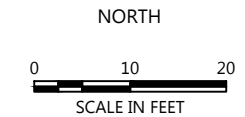

- NOTES:
- HORIZONTAL DATUM: WASHINGTON STATE PLANE NORTH ZONE, NAD 83, U.S. FEET.
 - VERTICAL DATUM: NAVD88

DRAFT
 AT FULL SIZE IF NOT ONE INCH SCALE ACCORDINGLY



REVISIONS				
REV	DATE	BY	APP'D	DESCRIPTION

DESIGNED BY: D. RICE
 DRAWN BY: M. PRATSCNER
 CHECKED BY: R. MONTGOMERY
 APPROVED BY: D. RICE
 SCALE: AS NOTED
 DATE: APRIL 2017

EIGHTMILE LAKE RESTORATION PROJECT
EMBANKMENT SECTIONS (2)

C-05
 SHEET NO. 11 OF 15

K:\Project\0204-Aspect Consulting, L.L.C.\Eightmile Lake\Construction Plans\0204-PL-008 EMBANKMENT SPILL WSEL.dwg C-06
Apr 26, 2017 8:15am drice

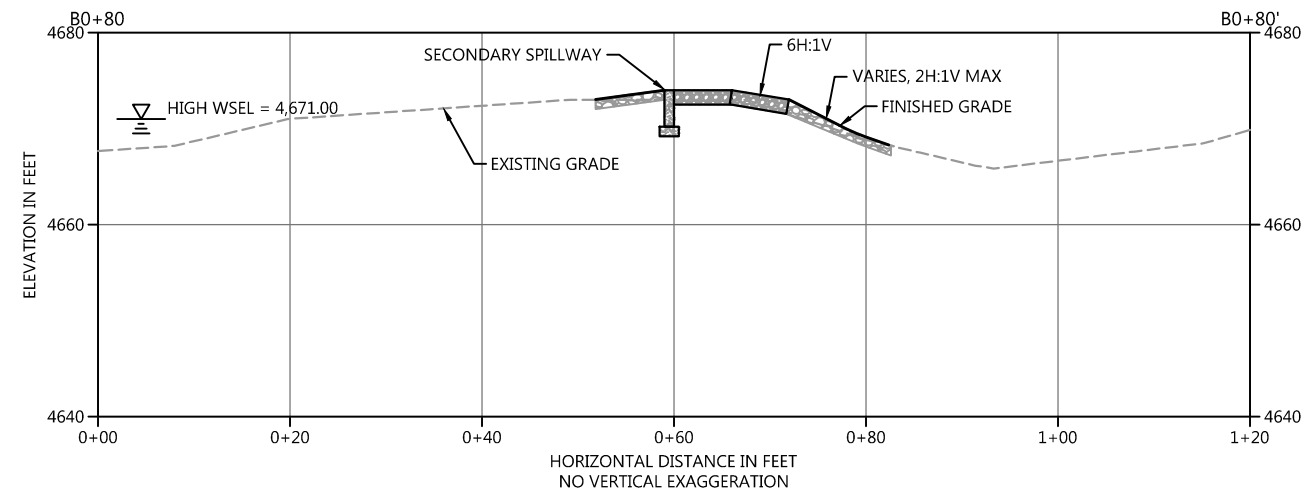

B0+80 SECTION
C-2
HORIZ. SCALE: 1" = 10'
VERT. SCALE: 1" = 10'

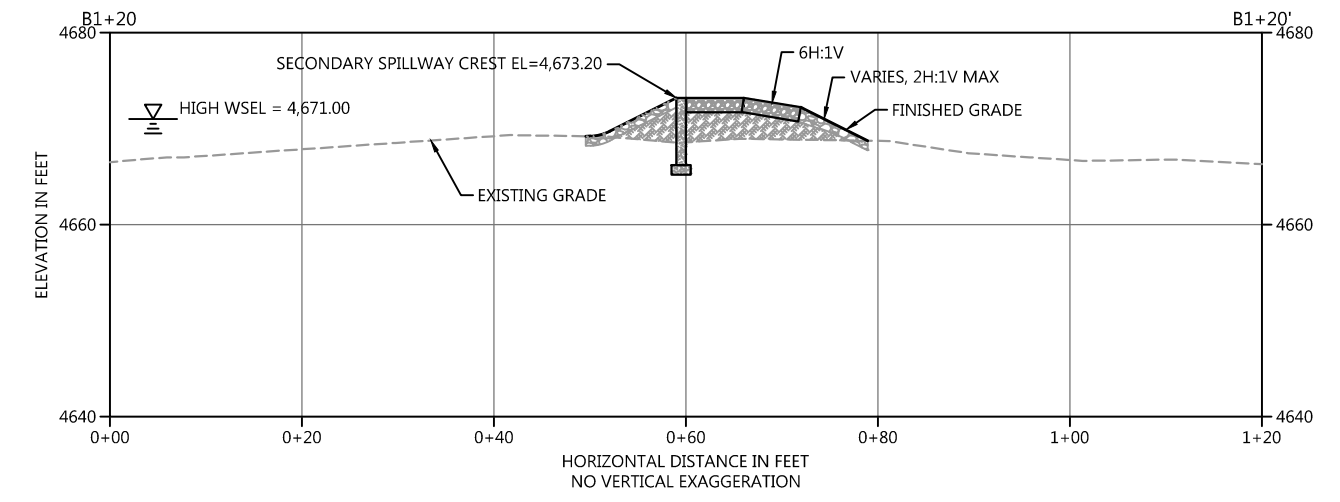

B1+20 SECTION
C-2
HORIZ. SCALE: 1" = 10'
VERT. SCALE: 1" = 10'

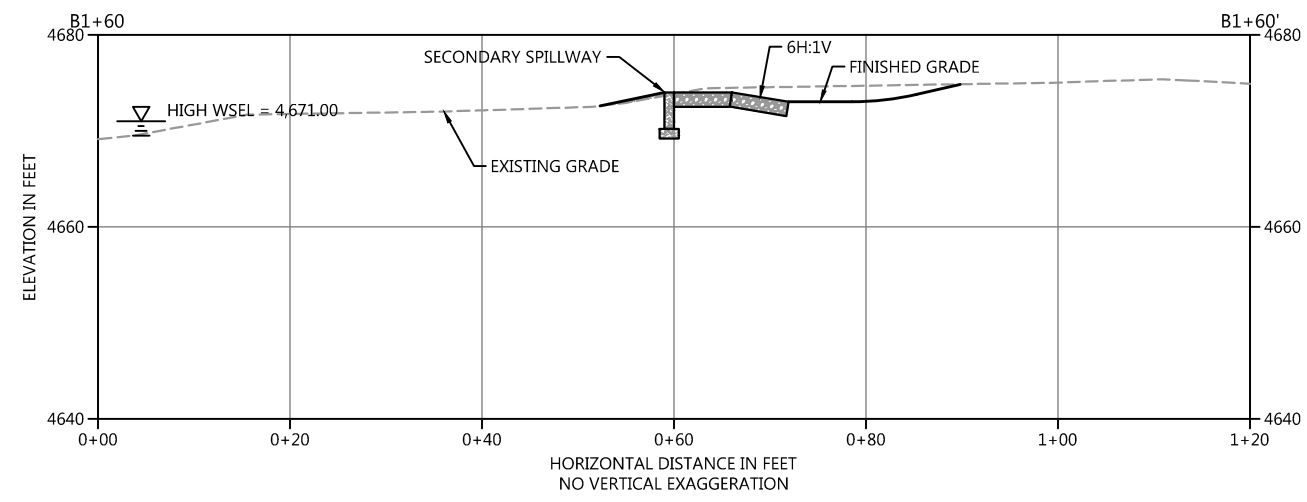

B1+60 SECTION
C-2
HORIZ. SCALE: 1" = 10'
VERT. SCALE: 1" = 10'

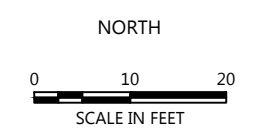

- NOTES:
- HORIZONTAL DATUM: WASHINGTON STATE PLANE NORTH ZONE, NAD 83, U.S. FEET.
 - VERTICAL DATUM: NAVD88

AT FULL SIZE IF NOT ONE INCH SCALE ACCORDINGLY

DRAFT



REVISIONS				
REV	DATE	BY	APP'D	DESCRIPTION

DESIGNED BY: D. RICE
 DRAWN BY: M. PRATSCHNER
 CHECKED BY: R. MONTGOMERY
 APPROVED BY: D. RICE
 SCALE: AS NOTED
 DATE: APRIL 2017

EIGHTMILE LAKE RESTORATION PROJECT

EMBANKMENT SECTIONS (3)

C-06

SHEET NO. 12 OF 15

K:\Project\0204-Aspect Consulting, L.L.C\Idle Creek Comp. Water Mgt\Eightmile Lake\Construction Plans\0204-PL-009 OUTLET.dwg, C-07
 Apr 26, 2017 8:23am drice

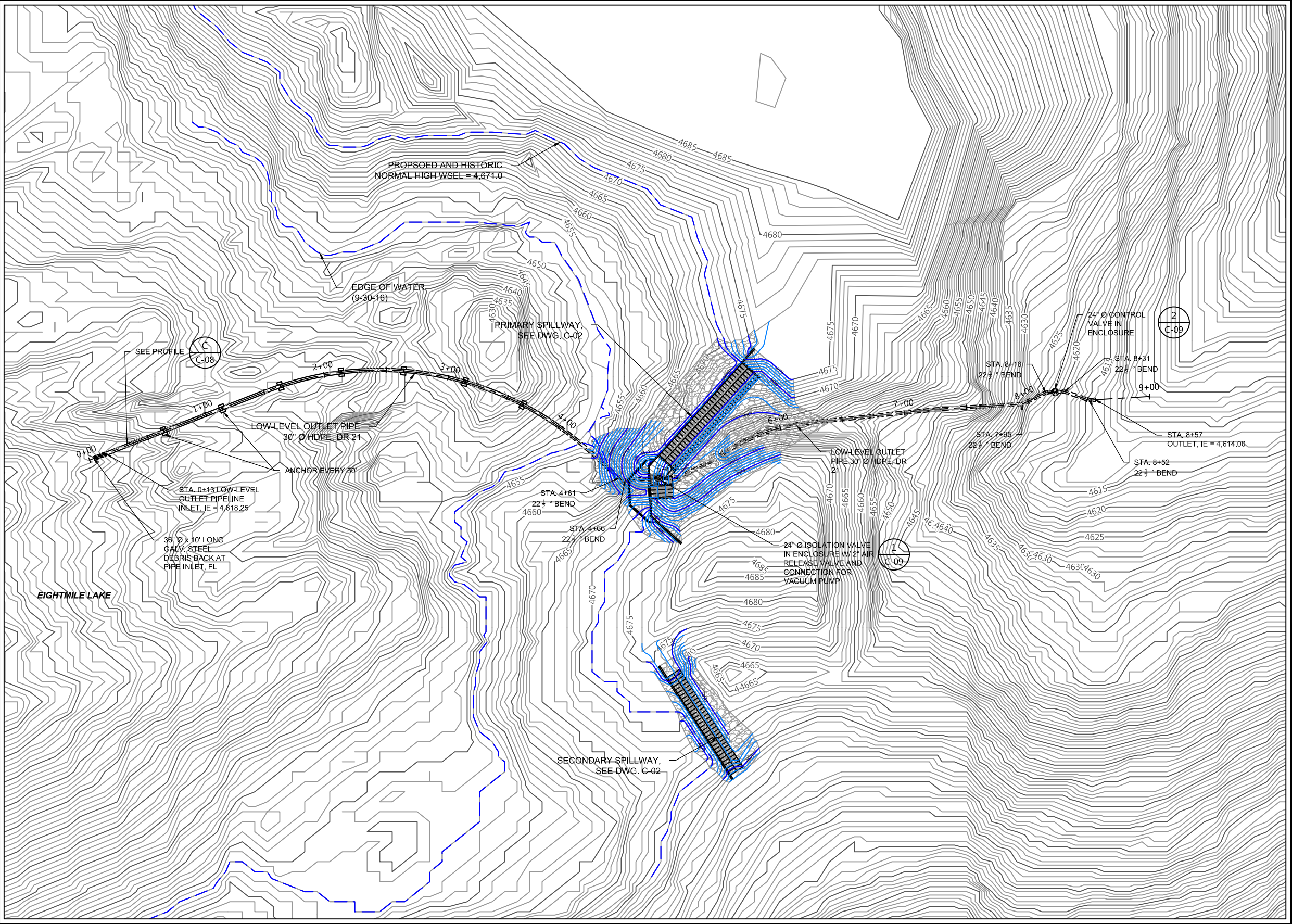

- LEGEND:
- 4570— EXISTING MAJOR CONTOUR (5')
 - EXISTING MINOR CONTOUR (1')
 - MAJOR CONTOUR (5' INTERVAL)
 - MINOR CONTOUR (1' INTERVAL)
 - ==== SUBMERGED PIPELINE
 - ==== BURIED PIPELINE
 - ▨ SLOPE ARMORING
 - ▨ SPILLWAY GABIONS W/CONCRETE
 - ▭ REINFORCED CONCRETE WALL



- NOTES:
1. HORIZONTAL DATUM: WASHINGTON STATE PLANE NORTH ZONE, NAD 83, U.S. FEET.
 2. VERTICAL DATUM: NAVD88

AT FULL SIZE IF NOT ONE INCH SCALE ACCORDINGLY

DRAFT



REVISIONS				
REV	DATE	BY	APP'D	DESCRIPTION

DESIGNED BY: D. RICE
 DRAWN BY: M. PRATSCHNER
 CHECKED BY: R. MONTGOMERY
 APPROVED BY: D. RICE
 SCALE: AS NOTED
 DATE: APRIL 2017

EIGHTMILE LAKE RESTORATION PROJECT

LOW-LEVEL OUTLET PLAN

C-07

SHEET NO. 13 OF 15

Apr 26, 2017 8:25am drice K:\Project\0204-Aspect Consulting, LLC\Eightmile Lake\Construction Plans\0204-PL-009-OUTLET.dwg C-08

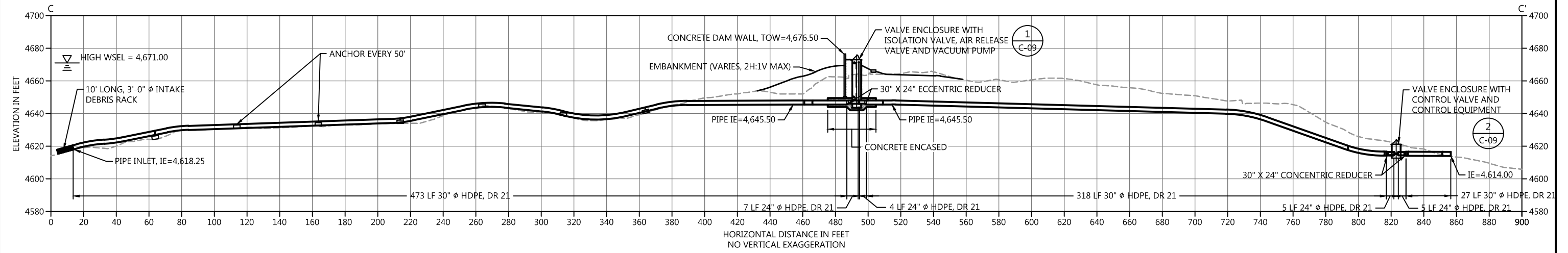

C
C-07 **LOW-LEVEL OUTLET PROFILE**
HORIZ. SCALE: 1" = 30'
VERT. SCALE: 1" = 30'

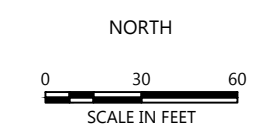

- NOTES:
- HORIZONTAL DATUM: WASHINGTON STATE PLANE NORTH ZONE, NAD 83, U.S. FEET.
 - VERTICAL DATUM: NAVD88

AT FULL SIZE IF NOT ONE INCH SCALE ACCORDINGLY

DRAFT



REVISIONS				
REV	DATE	BY	APP'D	DESCRIPTION

DESIGNED BY: D. RICE
 DRAWN BY: M. PRATSCHNER
 CHECKED BY: R. MONTGOMERY
 APPROVED BY: D. RICE
 SCALE: AS NOTED
 DATE: APRIL 2017

EIGHTMILE LAKE RESTORATION PROJECT

LOW-LEVEL OUTLET PROFILE

C-08

SHEET NO. 14 OF 15

K:\Projects\2014-Aspect Consulting, L.L.C.\Idle Creek Comp. Water Mgt\Eightmile Lake\Construction Plans\0204-PL-008 EMBANKMENT SPILL XSEC.dwg C-09
 Jun 02, 2017 6:04am drice

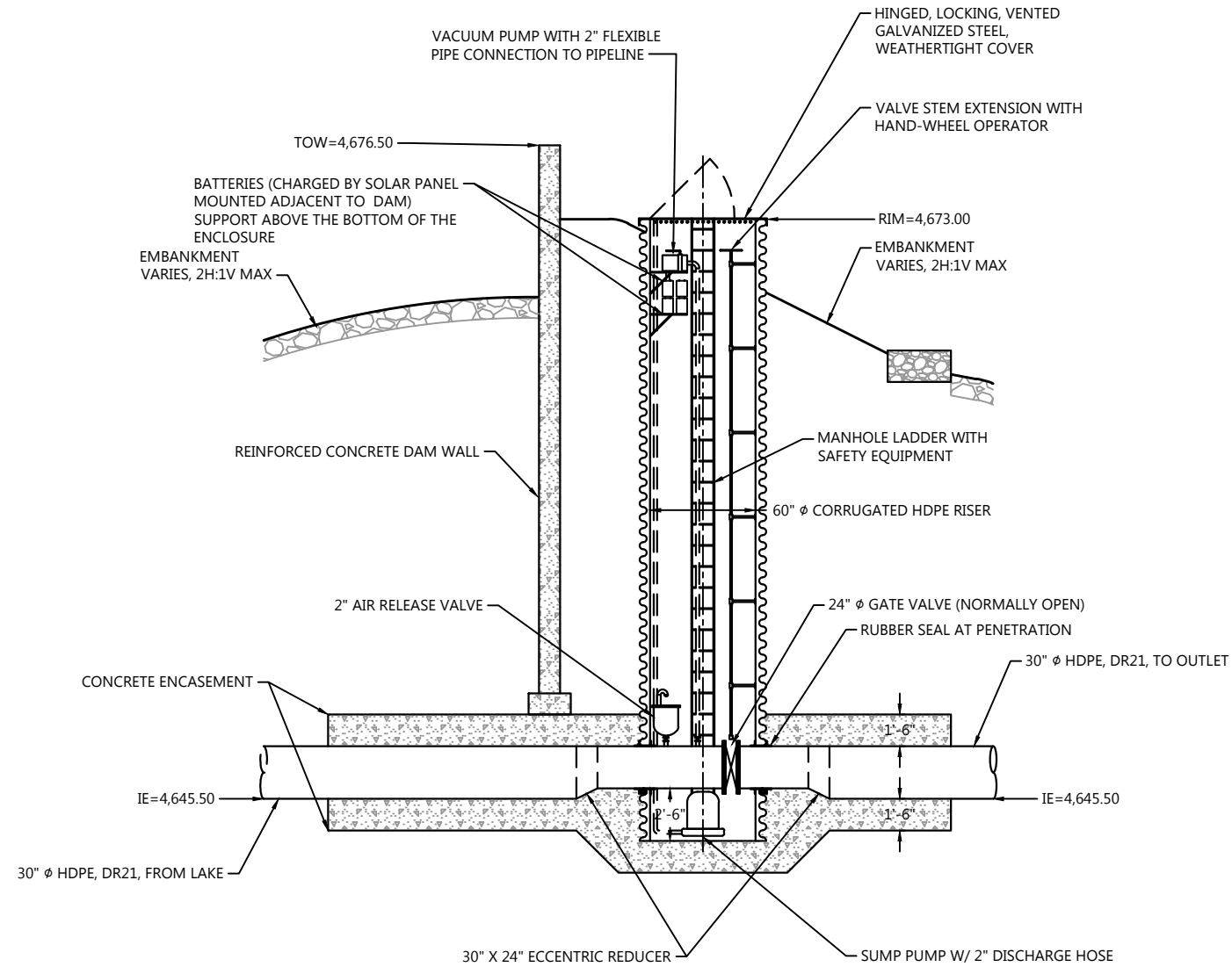

1 ISOLATION VALVE ENCLOSURE
 C-07 SCALE: 1" = 4'

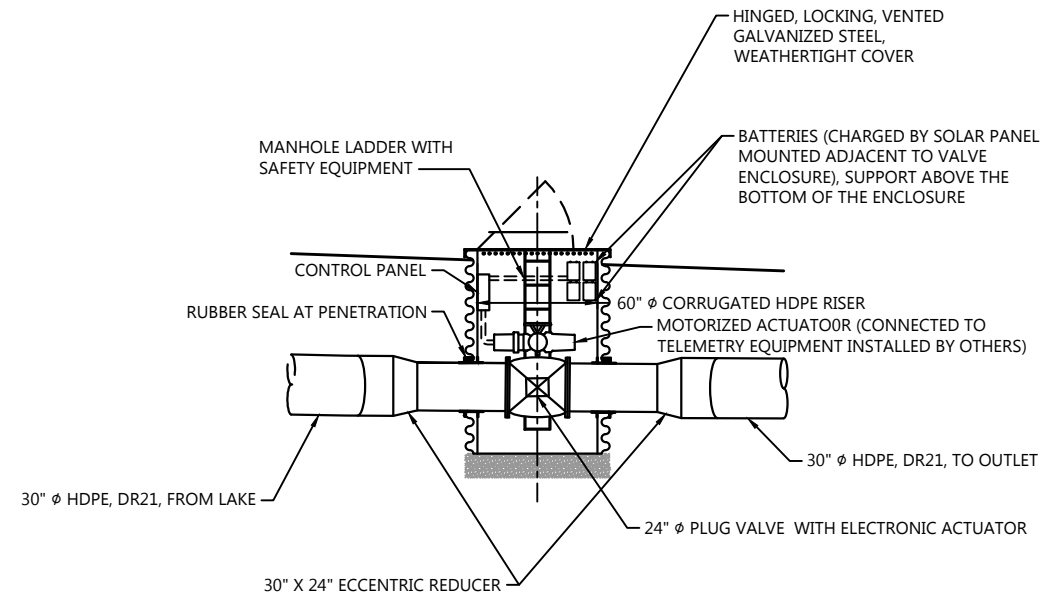

2 CONTROL VALVE ENCLOSURE
 C-07 SCALE: 1" = 4'

DRAFT



REVISIONS				
REV	DATE	BY	APP'D	DESCRIPTION

DESIGNED BY: D. RICE
 DRAWN BY: M. PRATSCHNER
 CHECKED BY: R. MONTGOMERY
 APPROVED BY: D. RICE
 SCALE: AS NOTED
 DATE: APRIL 2017

EIGHTMILE LAKE RESTORATION PROJECT

DETAILS

C-09

SHEET NO. 15 OF 15

AT FULL SIZE IF NOT ONE INCH SCALE ACCORDINGLY

Appendix B
Photographs

Photograph 1
Existing Dam and Spillway

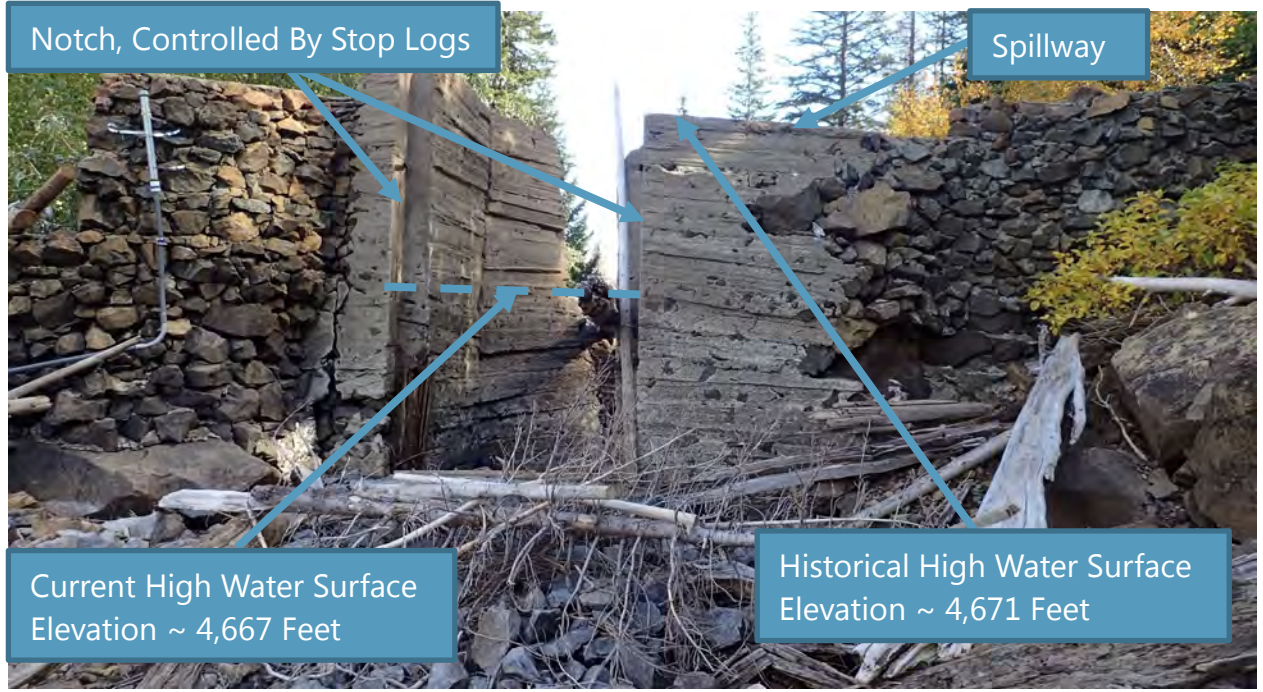

Photograph 2
Existing Embankment

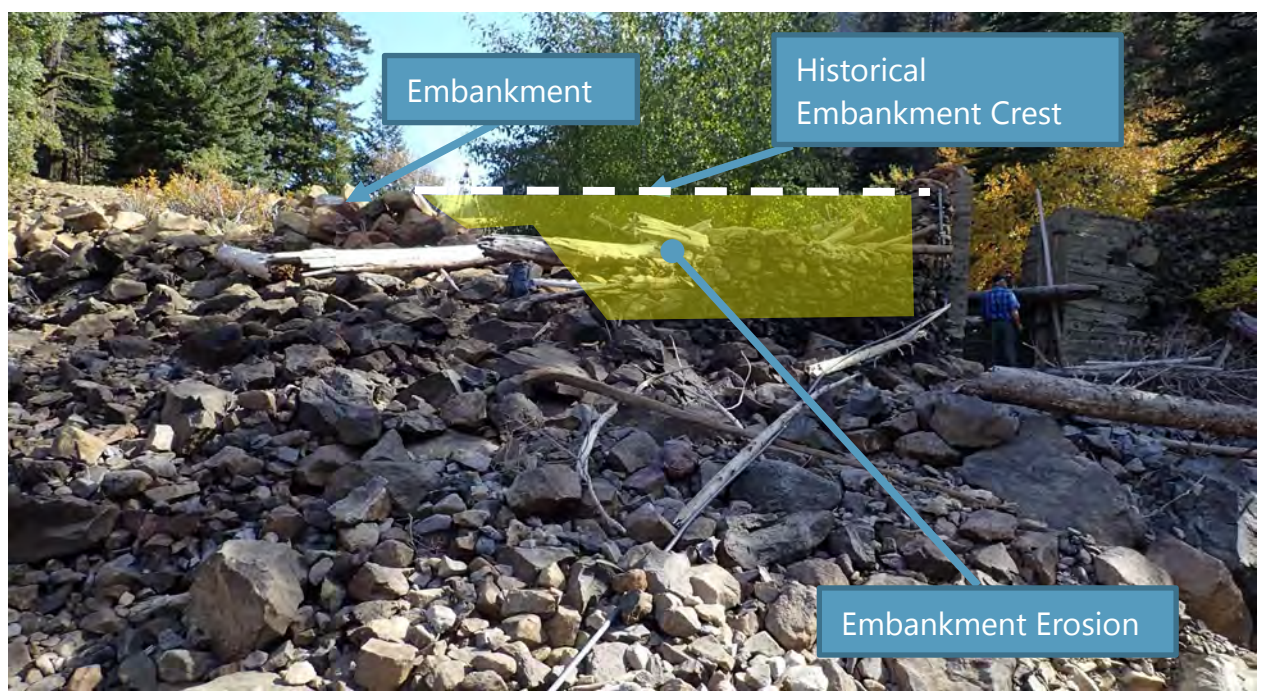

Photograph 3
Low-Level Outlet Gate

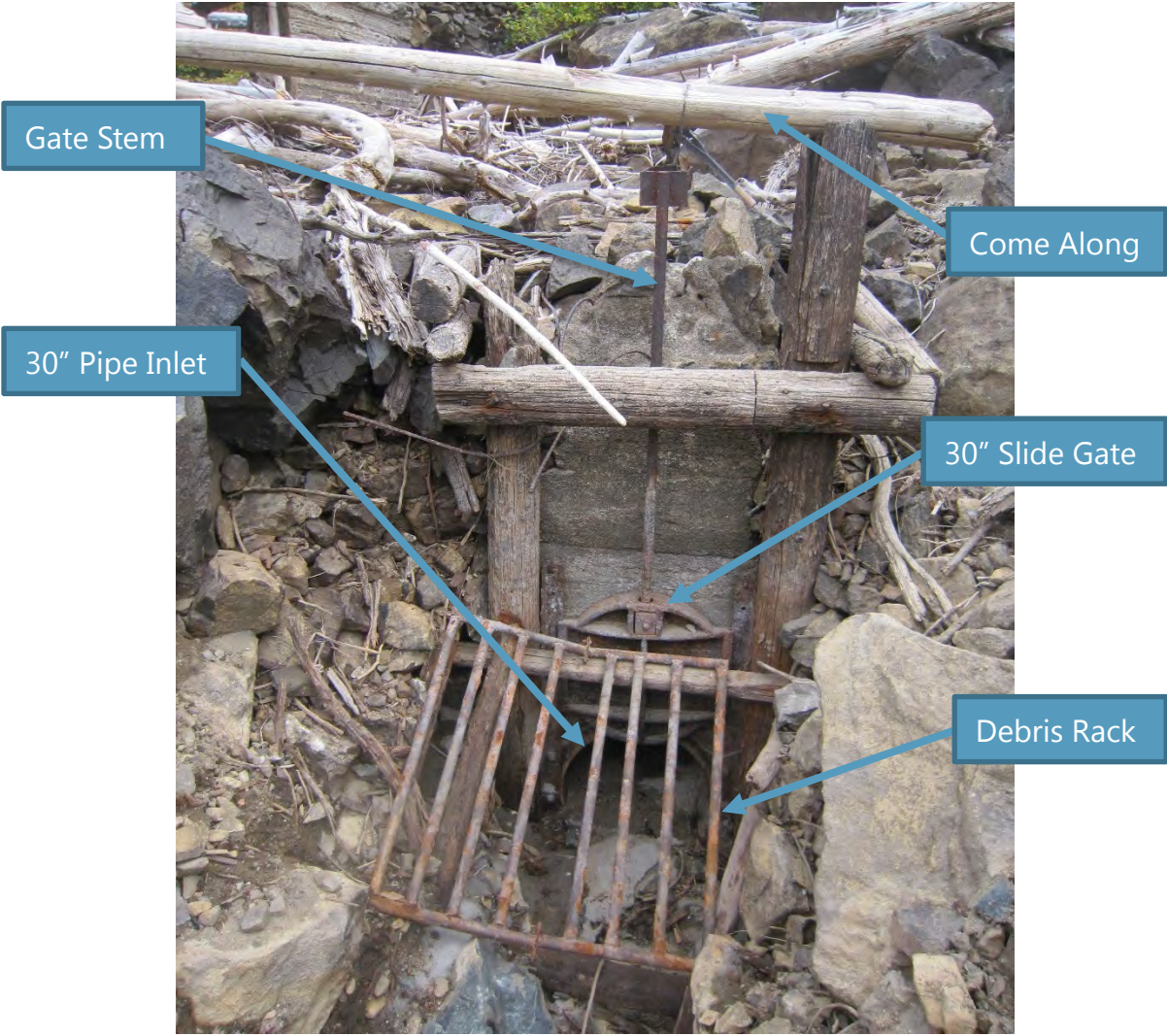

Photograph 4
Eightmile Lake – Drawn Down (September 15, 2015)



Photograph 5
Eightmile Lake – Full (July 25, 2016)



Photograph 6
Eightmile Lake – Drawn Down (September 15, 2015)



Photograph 7
Eightmile Lake – Near Full (August 29, 2012)



Photograph 8
Low-Level Outlet Pipe, Near Pipe Inlet

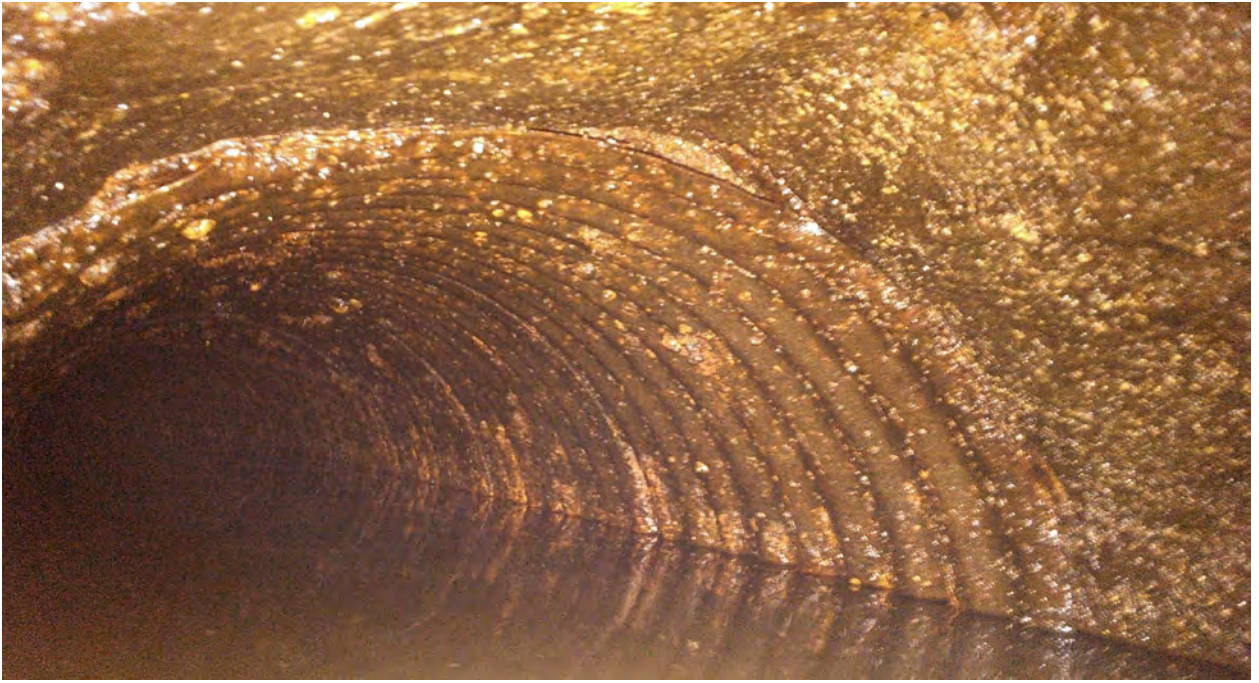

Photograph 9
Low-Level Outlet Pipe, Log-Stave Section



Photograph 10
Low-Level Outlet Pipe, Wood-Stave Section



Photograph 11
Low-Level Outlet Pipe, Near Pipe Outlet



Appendix C

Downstream Hazard Analysis Worksheet

**WORKSHEET
DAM SAFETY GUIDELINES**

**SELECTION OF DESIGN/PERFORMANCE GOALS
FOR CRITICAL PROJECT ELEMENTS**

PROJECT NAME: Eightmile Lake Storage Restoration Feasibility Study

DAM NAME: Eightmile Lake

CONSEQUENCES EVALUATED FOR FAILURE OF Total failure at base of dam
AT RESERVOIR LEVEL OF EL=4673

SUMMARY SHEET

	CONSEQUENCE RATING POINTS
I. CAPITAL VALUE OF PROJECT	<u>110</u>
II. POPULATION AT RISK	<u>295</u>
III. DOWNSTREAM PROPERTY AT RISK	<u>77</u>
BASE POINTS	150
CUMULATIVE CONSEQUENCE RATING POINTS	<u>632</u>

CUMULATIVE CONSEQUENCE RATING POINTS

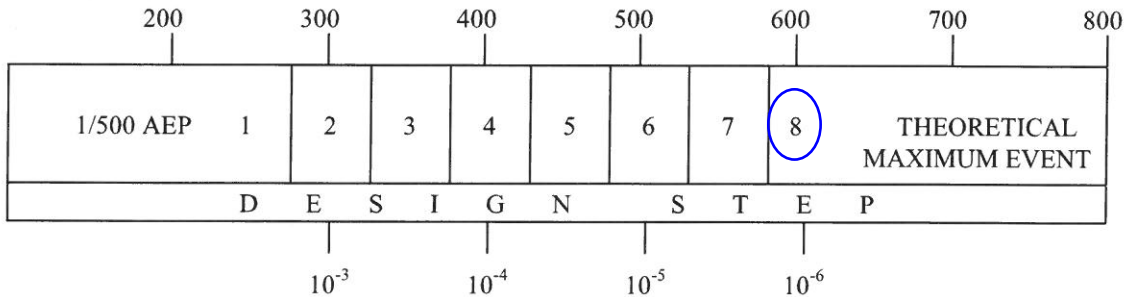

DESIGN/PERFORMANCE GOAL - ANNUAL EXCEEDANCE PROBABILITY

DESIGN STEP NUMBER 8

PROJECT ENGINEER David W. Rice

DATE 02/2017

I. CAPITAL VALUE OF PROJECT

A. DAM HEIGHT INDEX

	Dam Height (feet)	<u>Consequence Rating Points</u>
Maximum Dam Height	<u>26</u>	<u>60</u>

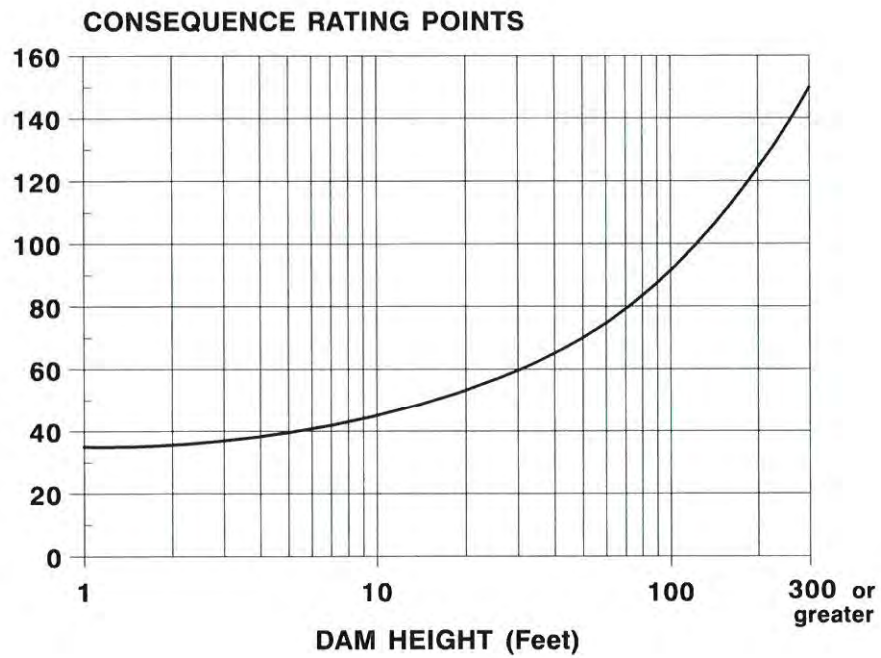

I. CAPITAL VALUE OF PROJECT - Continued

B. VALUE OF RESERVOIR CONTENTS/PROJECT BENEFITS

<u>Mandatory Consideration for Some Projects</u>	<u>Points Per Item</u>	<u>Consequence Rating Points</u>
1. Public Water Supply Storage	25 - 75	_____
 <u>Discretionary Considerations</u>		
2. Irrigation Water Supply Storage	10 - 75	<u>40</u>
3. Industrial Water Supply Storage	10 - 75	_____
4. Hydropower Generation Facilities	10 - 75	_____
5. Mining or Manufacturing Process Water	10 - 75	_____
6. Aesthetics, Recreation or Wildlife Habitat	10 - 25	<u>10</u>
7. Other _____		_____

Describe: _____

Assignment of consequence rating points to dams which provide a community with a limited resource, such as a public water supply, is mandatory.

Assignment of consequence rating points to dams which provide benefits primarily to the owner, is at the discretion of the owner and/or project engineer.

A wide range of consequence rating points are possible for the various project benefits. Selection of an appropriate value should be based on the size and importance of the project benefit under consideration relative to the broad range of projects of that type. In addition, a larger or smaller value may be selected depending on the owner's and/or project engineer's perceived need for conservatism in protecting project benefits.

SUBSECTION I - SUBTOTAL OF CONSEQUENCE RATING POINTS 110

II. POPULATION AT RISK

A. CATASTROPHIC POTENTIAL INDEX

- | | | |
|----|--|--------------------------|
| 1. | Estimated Dam Breach Peak Discharge at Dam Site due to Failure of Critical Project Element | <u>24,000-45,000</u> cfs |
| 2. | Estimated 100 year Flood Peak Discharge | <u>1620</u> cfs |

Taken on a Natural Watercourse at First Location Downstream of the Dam Where There is a Potential for Loss of Life or

If There is No Downstream Development, It is Taken on the Natural Watercourse at a Point 1 Mile Downstream of Dam

- | | <u>Index</u> | <u>Consequence Rating Points</u> |
|--|--------------|----------------------------------|
| 3. Ratio of Dam Breach Peak Discharge to 100 Year Flood Peak Discharge | <u>11-22</u> | <u>30</u> |

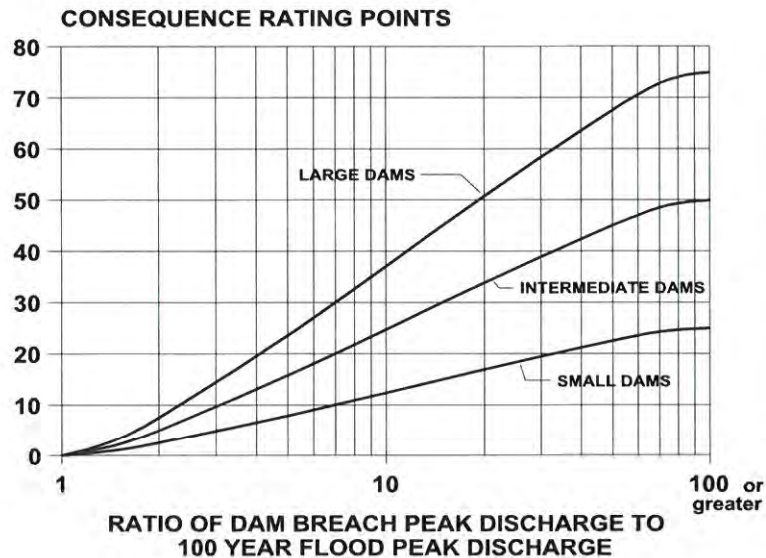

II. POPULATION AT RISK - Continued

B. POPULATION AT RISK INDEX

	<u>No. of Persons</u>	<u>Consequence Rating Points</u>
1. Estimated Current Population at Risk (PAR)	<u>150</u>	
2. Increase in Population Due to Development	<u> </u>	
3. TOTAL - Future Population at Risk	<u>150</u>	<u>175</u>

Describe: _____

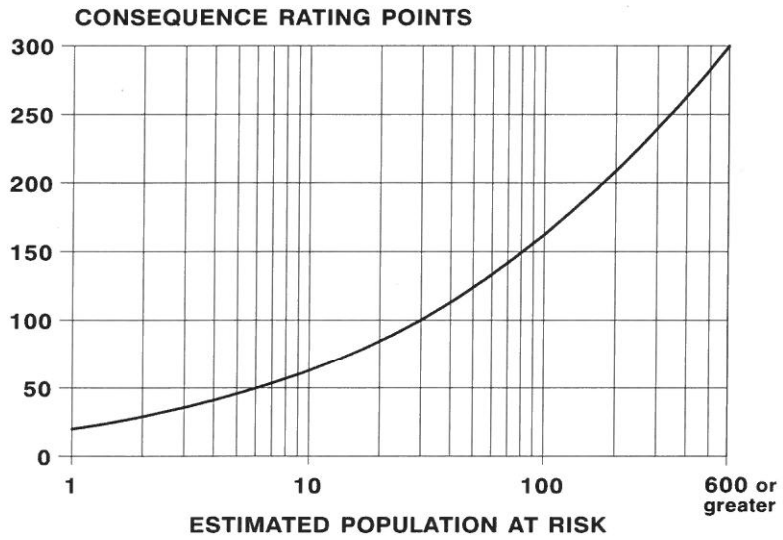

II. POPULATION AT RISK - Continued

C. ADEQUACY OF WARNING

To be used when there is Population at Risk

FACTOR	ADEQUATE WARNING	MARGINAL WARNING	INADEQUATE WARNING
ADVANCED WARNING TIME	More than 30 minutes <i>0 Warning Index Points</i>	More Than 10 Minutes but Less Than 30 Minutes <i>25 Warning Index Points</i>	Less Than 10 Minutes <i>50 Warning Index Points</i>
LIKELIHOOD OF DANGEROUS SITUATION TO BE OBSERVED AND NOTIFICATION GIVEN TO GENERAL PUBLIC	Dam Owner Resides near Dam Site, or Designated Responsible Party Has Reasonably Short Access Time to Dam Site and has Duty of Initiating Warning <i>0 Warning Index Points</i>	Designated Responsible Party not Located near Dam Site, but Dam Site is Visible to General Public. There is Reasonably Good Vehicular Access near Dam Site and Intermittent Vehicular Traffic. <i>15 Warning Index Points</i>	No Designated Responsible Party near Dam Site. Dam in Remote Location. Poor Vehicular Access to Dam Site. <i>30 Warning Index Points</i>
DOWNSTREAM VALLEY SETTING AND EASE OF EVACUATION	Valleys with Good Access to High Ground and Good Roadway Systems for Escape Routes <i>0 Warning Index Points</i>	Valleys with Limited Access to High Ground and Limited Roadway Systems <i>10 Warning Index Points</i>	Narrow Confining Valley with Roadways near the Stream Bank or Along Valley Floor and Poor Access to High Ground <i>20 Warning Index Points</i>

<u>Item</u>	<u>Warning Index Points</u>	<u>Consequence Rating Points</u>
1. Advanced Warning Time	<u>50</u>	
2. Likelihood of Dangerous Situations to be Observed and Notification Give to Public	<u>30</u>	
3. Downstream Valley Setting and Ease of Evacuation	<u>10</u>	
TOTAL WARNING INDEX POINTS	<u>90</u>	
WARNING RATED AS _____		<u>90</u>

II. POPULATION AT RISK - Continued

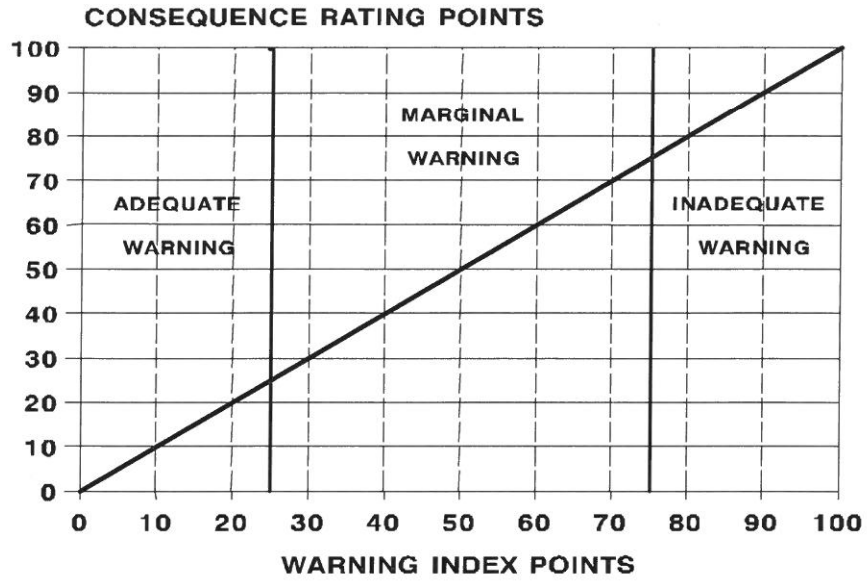

Describe: _____

SUBSECTION II - SUBTOTAL OF CONSEQUENCE RATING POINTS 295

III. DOWNSTREAM PROPERTY AT RISK

A. RESIDENTIAL UNITS

No. of Items

Consequence
Rating Points

1. Equivalent Single Family Dwelling Units

50

55

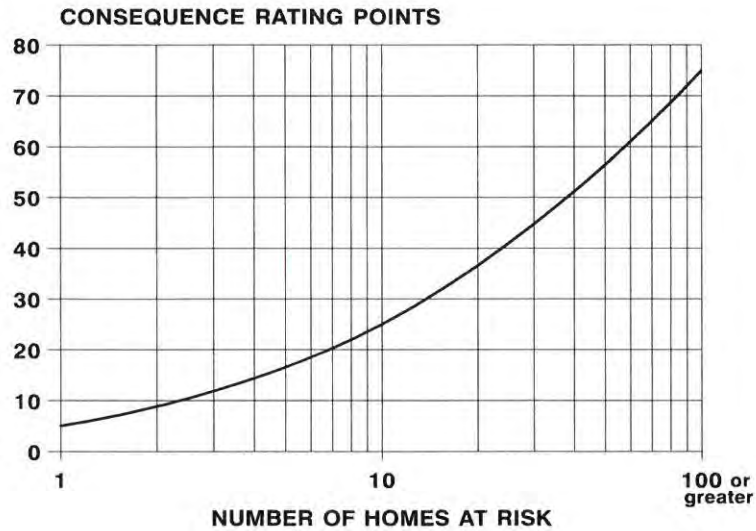

B. LIFELINE FACILITIES

Points
Per Item

No. of
Items

Consequence
Rating Points

1. Transportation Links - Bridges and Stream Crossings

a. Freeways/interstate highways Railway main lines

25

b. State highways

10

c. Other public roads Railway spur lines

2 - 5

3

12

III. DOWNSTREAM PROPERTY AT RISK - Continued

	<u>Points Per Item</u>	<u>No. of Items</u>	<u>Consequence Rating Points</u>
2. <u>Water Supply Systems</u>			
a. Storage Reservoirs (Downstream)	10 - 75	_____	_____
b. Treatment Facilities	10 - 25	_____	_____
c. Delivery Systems	5 - 25	_____	_____
3. <u>Domestic Waste Treatment Systems</u>			
a. Treatment Facilities	5 - 25	_____	_____
4. <u>Electric Power Facilities</u>			
a. Electric power plant or Appurtenant works	5 - 75	_____	_____
5. <u>Emergency Response Facilities</u>			
a. Hospitals, Police, Fire, Paramedical Units	10 - 75	_____	_____

C. OTHER IMPORTANT FACILITIES

1. Public Buildings, Schools, Libraries	10 - 75	_____	_____
2. Fish Hatcheries	5 - 25	<u>1</u>	<u>10</u>
3. Industrial, Commercial and Agricultural Developments	5 - 75	_____	_____
4. Other Facilities or Considerations		_____	_____

A wide range of consequence rating points are possible for the damages that could occur to property and lifeline facilities. Selection of an appropriate value should be based on the size and importance of the features under consideration relative to the broad range of features of that type. In addition, a larger or smaller value may be selected depending on the owner's and/or project engineer's perceived need for the protection against property damages.

III. DOWNSTREAM PROPERTY AT RISK - Continued

D. ENVIRONMENTAL DEGRADATION

	<u>Points Per Item</u>	<u>No. of Items</u>	<u>Consequence Rating Points</u>
1. <u>Deleterious contents in proposed reservoir</u>			
a. Release of reservoir contents will result in long term environmental degradation	10 - 75	_____	_____
b. Release of reservoir contents will result in temporary, minor environmental degradation	5 - 20	_____	_____
2. <u>Damage to downstream facilities could result in release of deleterious materials stored on-site</u>			
a. Release of deleterious materials will result in long term environmental degradation	10 - 75	_____	_____
b. Release of deleterious materials will result in temporary, minor environmental degradation	5 - 20	_____	_____

Description of damages to property, lifeline facilities, and environmental degradation: _____

SUBSECTION III - SUBTOTAL OF CONSEQUENCE RATING POINTS 77

GENERAL NOTES AND COMMENTS:

Appendix D

Precipitation Data Lookup Worksheets

Precipitation Magnitude-Frequency Gridded Data Set Lookup Calculator

This Work Book contains a Visual Basic for Applications macro that interpolates precipitation magnitude from gridded data set files. The user inputs the latitude and longitude of the location of interest, the precipitation duration (2-hours, 6-hours, or 24-hours), and the interpolation method. Clicking the **Calculate** button runs the macro and outputs the Climatic Region Number, L-Moment Statistics, and Precipitation Magnitude-Frequency Statistics below.



7326 Boston Harbor Road NE
 Olympia, WA 98506
 (360) 570-3450
 www.mgsenr.com

User Inputs	
Latitude (Decimal Degrees)	47.5199
Longitude (Decimal Degrees)	120.87919
Duration (hours)	6
Grid Cell Interpolation Method	1

Project Name: **Eightmile Lake**

(Enter 2, 6, or 24)

(Enter 0 for Center of Grid-Cell or 1 for Inverse Distance Weighting)

Calculate

Program Output	
Climatic Region Number	14
Mean Annual Precipitation (inches)	65.1
At-Site Mean (inches)	1.513
L-Cv	0.1527
L-Skew	0.1724
Hondo	-0.150

Precipitation Magnitude Frequency Output, 6-Hour Duration	
Precipitation Frequency	
10-Year	2.06
25-Year	2.39
100-Year	2.90
Step 1	3.51
Step 2	3.79
Step 3	4.28
Step 4	4.78
Step 5	5.32
Step 6	5.88
Step 7	6.47
Step 8	7.09
Program Status Message	Successful

Eightmile Lake (Icicle and Peshastin Irrigation Districts)

Worksheet for Computation of Intermediate Precipitation Magnitude-Frequency Curve
Reference: Technical Note 3, Oct 2009 revision

JTS, 12/09/2016

page 2 of 3

Comparison to PMP for general storm. Ref: HMR-57, Map 1 - NW, Table 10.10.

PMP for a 6-hour period is estimated as a percentage of the 24-hour PMP. The percentage factor varies by climatic region as follows :

	Western Washington				Eastern Washington	
	<u>Coast</u>	<u>Olympics</u>	<u>Cascades</u>	<u>Puget Sound</u>	<u>Mountains</u>	<u>Central Basin</u>
Regions :	5	151-142	15-154	31-32	14-147-13	77-07
Factor :	0.43	0.40	0.40	0.44	0.52	0.59

This project :

General storm, 24-hour PMP = $\frac{\text{Input}}{\text{Input}}$ 18.5 in. From HMR-57 Map 1

For region: 14
6-hr PMP = $\frac{\text{Input}}{\text{Input}}$ 0.52 x 24-hr = 9.62 in.

Frequency / design step :	Step 3	Step 4	Step 5	Step 6	Step 7	Step 8
Scaling precipitation, P _{sd} (in.) :	4.92	5.50	6.12	6.76	7.44	8.15
Percentage of 6-hr PMP (%) :	51.1	57.2	63.6	70.3	77.3	84.7

Note: Per Tech Note 3, page 10: For IDF = PMF, use PMP > Step 6.

Comparison to PMP for local storm (thunderstorm). Ref: HMR-57, Fig. 11.19 and 11.12, Table 11.4.

Local storm, 1-hour PMP = $\frac{\text{Input}}{\text{Input}}$ 6.6 in.
6-hour PMP = 115% x 1-hr = 7.6 in.

Frequency / design step :	Step 3	Step 4	Step 5	Step 6	Step 7	Step 8
Scaling precipitation, P _{sd} (in.) :	4.92	5.50	6.12	6.76	7.44	8.15
Percentage of 6-hr PMP (%) :	64.8	72.5	80.6	89.1	98.0	107.4

Note: Per Tech Note 3, page 10: For IDF = PMF, use PMP > Step 6.

Eightmile Lake (Icicle and Peshastin Irrigation Districts)

Worksheet for Computation of Intermediate Precipitation Magnitude-Frequency Curve
 Reference: Technical Note 3, Oct 2009 revision

JTS, 12/09/2016

page 3 of 3

Peak rainfall intensity for design storm.

Peak rainfall intensity (in/hr) = (total storm precip) x (peak intensity factor)

peak intensity factor = 0.27032	for Climatic Region	14
<i>(from Multipliers worksheet)</i>	Hyetograph no.	11

Frequency / design step :	10 yr	25 yr	100 yr	Step 1	Step 2	Step 3
Total precip for design storm :	4.46	5.16	6.26	7.59	8.20	9.24
Peak storm intensity (in/hr) :	1.21	1.40	1.69	2.05	2.22	2.50

Frequency / design step :	Step 4	Step 5	Step 6	Step 7	Step 8	PMP
Total precip for design storm :	10.33	11.49	12.70	13.97	15.31	18.08
Peak storm intensity (in/hr) :	2.79	3.11	3.43	3.78	4.14	4.89

Total storm multipliers for intermediate storm hyetographs

MDW, 10/13/09

page 1 of 1

Regions	Hyetograph	Total storm multiplier	Peak intensity factor
5	8	1.6810	0.31408
151-142	9	1.8580	0.28416
15-154	9	1.8580	0.28416
31-32	10	1.6670	0.33352
14	11	1.8790	0.27032
147-77-07	12	1.5515	0.40476
13	13	1.6285	0.35612

This project :

Region	Hyetograph	Multiplier	Factor
14	11 <i>Input</i>	1.8790 <i>Input</i>	0.27032 <i>Input</i>

Precipitation Magnitude-Frequency Gridded Data Set Lookup Calculator

This Work Book contains a Visual Basic for Applications macro that interpolates precipitation magnitude from gridded data set files. The user inputs the latitude and longitude of the location of interest, the precipitation duration (2-hours, 6-hours, or 24-hours), and the interpolation method. Clicking the **Calculate** button runs the macro and outputs the Climatic Region Number, L-Moment Statistics, and Precipitation Magnitude-Frequency Statistics below.



7326 Boston Harbor Road NE
Olympia, WA 98506
(360) 570-3450
www.mgsenr.com

User Inputs	
Latitude (Decimal Degrees)	47.5199
Longitude (Decimal Degrees)	120.87919
Duration (hours)	24
Grid Cell Interpolation Method	1

Project Name	Eightmile Lake
--------------	----------------

(Enter 2, 6, or 24)

(Enter 0 for Center of Grid-Cell or 1 for Inverse Distance Weighting)

Calculate

Program Output	
Climatic Region Number	14
Mean Annual Precipitation (inches)	65.1
At-Site Mean (inches)	3.367
L-Cv	0.1764
L-Skew	0.1666
Hondo	-0.050

Precipitation Magnitude Frequency Output, 24-Hour Duration	
Precipitation Frequency	
10-Year	4.79
25-Year	5.60
100-Year	6.82
Step 1	8.23
Step 2	8.84
Step 3	9.87
Step 4	10.90
Step 5	11.95
Step 6	13.01
Step 7	14.07
Step 8	15.15
Program Status Message	Successful

Eightmile Lake (Icicle and Peshastin Irrigation Districts)

Worksheet for Computation of **Long Duration** Precipitation Magnitude-Frequency Curve

Reference: Technical Note 3, Oct 2009 revision

JTS, 12/09/2016

page 1 of 2

Project data :

	<i>Input</i>		<i>Input</i>
Dam location:	T 24 N, R 16E, Section 33; 10 miles W of Leavenworth, WA		
Watershed Lat/Long:	47.5199 deg. N	-120.8792 deg. W	(> 3 decimal places)
Watershed elevation:	6026 feet		(Lat/Long and elev for centroid of watershed)
Climatic Region:	14		(MGS Look-up Calculator)
Mean Annual Precip:	65.1 inches		(MGS Look-up Calculator)
Duration of interest:	24 hours		(Index for long duration storm)
Design Step:	8		(Worksheet from Tech Note 2)
Drainage area:	6 sq.miles.		(Compare to small watershed < 10 sq.miles)
	<i>Input</i>		

Key equations :

Precipitation estimates are calculated from gridded data set files by the MGS Look-up Calculator (the "Calculator" tab in this workbook) using the four-parameter Kappa probability distribution. The specific equations are described in more detail in the following references :

Schaefer MG, Barker BL, Taylor GH and Wallis JR, Regional Precipitation-Frequency Analysis and Spatial Mapping of Precipitation for 24-Hour and 2-Hour Durations in Western Washington, prepared for Washington State Department of Transportation, Report WA-RD 544.1, MGS Engineering Consultants, March 2002.

Schaefer MG, Barker BL, Taylor GH and Wallis JR, Regional Precipitation-Frequency Analysis and Spatial Mapping of Precipitation for 24-Hour and 2-Hour Durations in Eastern Washington, prepared for Washington State Department of Transportation, MGS Engineering Consultants, January 2006.

The calculations were extended to the Dam Safety storms by the update to Technical Note 3. The gridded data sets are provided by Ecology along with this spreadsheet and look-up calculator.

Scaling precipitation, $P_{sd} = DF * P_{gds}$ Use design factor = 1.15 *Input*
 where: P_{gds} = estimated 24-hr precip for selected frequency, inches
 DF = design factor; DF = 1.15 for new dams
 P_{sd} = scaling precip for 24-hr index period, inches

Total storm precip = (scaling precip for 24-hr index) x (multiplier from mass curve for 72-hr storm)
 multiplier for 72-hr storm = 1.6854 for Climatic Region 14
 (from **Multipliers** worksheet) Hyetograph no. 17

This project :

Frequency / design step :	10 yr	25 yr	100 yr	Step 1	Step 2	Step 3
Precip estimate, P_{gds} (in.) :	4.79	5.60	6.82	8.23	8.84	9.87
Scaling precipitation, P_{sd} (in.) :	5.51	6.45	7.84	9.46	10.17	11.35
Total precip for design storm :	9.29	10.86	13.21	15.95	17.14	19.12
Frequency / design step :	Step 4	Step 5	Step 6	Step 7	Step 8	PMP
Precip estimate, P_{gds} (in.) :	10.90	11.95	13.01	14.07	15.15	18.50
Scaling precipitation, P_{sd} (in.) :	12.54	13.74	14.96	16.18	17.42	18.50
Total precip for design storm :	21.13	23.16	25.21	27.27	29.36	31.18

Eightmile Lake (Icicle and Peshastin Irrigation Districts)

Worksheet for Computation of Long Duration Precipitation Magnitude-Frequency Curve
Reference: Technical Note 3, Oct 2009 revision

JTS, 12/09/2016

page 2 of 2

Comparison to PMP for general storm. Ref: HMR-57, Map 1 - NW.

General storm, 24-hour PMP = $\frac{\text{Input}}{\text{Input}}$ 18.5 in.

Frequency / design step :	Step 3	Step 4	Step 5	Step 6	Step 7	Step 8
Scaling precipitation, P _{sd} (in.) :	11.35	12.54	13.74	14.96	16.18	17.42
Percentage of 24-hr PMP (%) :	61.3	67.8	74.3	80.8	87.5	94.2

Note: Per Tech Note 3, page 8: For IDF = PMF, use PMP > Step 6.

Peak rainfall intensity for design storm.

Peak rainfall intensity (in/hr) = (total storm precip) x (peak intensity factor)
 peak intensity factor = 0.12340 for Climatic Region 14
 (from **Multipliers** worksheet) Hyetograph no. 17

Frequency / design step :	10 yr	25 yr	100 yr	Step 1	Step 2	Step 3
Total precip for design storm :	9.29	10.86	13.21	15.95	17.14	19.12
Peak storm intensity (in/hr) :	1.15	1.34	1.63	1.97	2.11	2.36

Frequency / design step :	Step 4	Step 5	Step 6	Step 7	Step 8	PMP
Total precip for design storm :	21.13	23.16	25.21	27.27	29.36	31.18
Peak storm intensity (in/hr) :	2.61	2.86	3.11	3.37	3.62	3.85

Total storm multipliers for long duration storm hyetographs

MDW, 10/13/09

page 1 of 1

Regions	Hyetograph	Total storm multiplier	Peak intensity factor
5	14	1.4643	0.11756
151-142	15	1.6215	0.09124
15-154	15	1.6215	0.09124
31-32	16	1.4153	0.13280
14	17	1.6854	0.12340
147-77-07	18	1.2545	0.21360
13	19	1.4473	0.19620

This project :

Region	Hyetograph	Multiplier	Factor
14	17 <i>Input</i>	1.6854 <i>Input</i>	0.12340 <i>Input</i>

Precipitation Magnitude-Frequency Gridded Data Set Lookup Calculator

This Work Book contains a Visual Basic for Applications macro that interpolates precipitation magnitude from gridded data set files. The user inputs the latitude and longitude of the location of interest, the precipitation duration (2-hours, 6-hours, or 24-hours), and the interpolation method. Clicking the **Calculate** button runs the macro and outputs the Climatic Region Number, L-Moment Statistics, and Precipitation Magnitude-Frequency Statistics below.



7326 Boston Harbor Road NE
Olympia, WA 98506
(360) 570-3450
www.mgsenr.com

User Inputs	
Latitude (Decimal Degrees)	47.5199
Longitude (Decimal Degrees)	120.87919
Duration (hours)	2
Grid Cell Interpolation Method	1

Project Name	Eightmile Lake
--------------	----------------

(Enter 2, 6, or 24)

(Enter 0 for Center of Grid-Cell or 1 for Inverse Distance Weighting)

Calculate

Program Output	
Climatic Region Number	14
Mean Annual Precipitation (inches)	65.1
At-Site Mean (inches)	0.726
L-Cv	0.1414
L-Skew	0.2074
Hondo	-0.150

Precipitation Magnitude Frequency Output, 2-Hour Duration	
Precipitation Frequency	
10-Year	0.97
25-Year	1.13
100-Year	1.39
Step 1	1.73
Step 2	1.89
Step 3	2.19
Step 4	2.52
Step 5	2.89
Step 6	3.30
Step 7	3.75
Step 8	4.26
Program Status Message	Successful

Eightmile Lake (Icicle and Peshastin Irrigation Districts)

Worksheet for Computation of **Short Duration** Precipitation Magnitude-Frequency Curve

Reference: Technical Note 3, Oct 2009 revision

JTS, 12/09/2016

page 1 of 2

Project data:	<i>Input</i>	<i>Input</i>
Dam location:	T 24 N, R 16E, Section 33; 10 miles W of Levenworth, WA	
Watershed Lat/Long:	47.5199 deg. N	-120.8792 deg. W (> 3 decimal places)
Watershed elevation:	6026 feet	(Lat/Long and elev for centroid of watershed)
Climatic Region:	14	(MGS Look-up Calculator)
Mean Annual Precip:	65.1 inches	(MGS Look-up Calculator)
Duration of interest:	2 hours	(Index for short duration storm)
Design Step:	8	(Worksheet from Tech Note 2)
Drainage area:	6 sq.miles.	(Compare to small watershed < 1 sq.mile.)
	<i>Input</i>	

Key equations :

Precipitation estimates are calculated from gridded data set files by the MGS Look-up Calculator (the "Calculator" tab in this workbook) using the four-parameter Kappa probability distribution. The specific equations are described in more detail in the following references :

Schaefer MG, Barker BL, Taylor GH and Wallis JR, Regional Precipitation-Frequency Analysis and Spatial Mapping of Precipitation for 24-Hour and 2-Hour Durations in Western Washington, prepared for Washington State Department of Transportation, Report WA-RD 544.1, MGS Engineering Consultants, March 2002.

Schaefer MG, Barker BL, Taylor GH and Wallis JR, Regional Precipitation-Frequency Analysis and Spatial Mapping of Precipitation for 24-Hour and 2-Hour Durations in Eastern Washington, prepared for Washington State Department of Transportation, MGS Engineering Consultants, January 2006.

The calculations were extended to the Dam Safety storms by the update to Technical Note 3. The gridded data sets are provided by Ecology along with this spreadsheet and look-up calculator.

Scaling precipitation, $P_{sd} = DF * P_{gds}$ Use design factor = 1.15 *Input*
 where: P_{gds} = estimated 2-hr precip for selected frequency, inches
 DF = design factor; DF = 1.15 for new dams
 P_{sd} = scaling precip for 2-hr index period, inches

Total storm precip = (scaling precip for 2-hr index) x (multiplier from mass curve for 4-hr storm)
 multiplier for 4-hr storm = 1.0910 for Climatic Region 14
 (from **Multipliers** worksheet) Hyetograph no. 6

This project :

Frequency / design step :	10 yr	25 yr	100 yr	Step 1	Step 2	Step 3
Precip estimate, P_{gds} (in.) :	0.97	1.13	1.39	1.73	1.89	2.19
Scaling precipitation, P_{sd} (in.) :	1.11	1.30	1.59	1.99	2.18	2.52
Total precip for design storm :	1.22	1.41	1.74	2.17	2.38	2.75
Frequency / design step :	Step 4	Step 5	Step 6	Step 7	Step 8	PMP
Precip estimate, P_{gds} (in.) :	2.52	2.89	3.30	3.75	4.26	7.26
Scaling precipitation, P_{sd} (in.) :	2.90	3.32	3.79	4.32	4.90	7.26
Total precip for design storm :	3.16	3.63	4.14	4.71	5.34	7.92

Eightmile Lake (Icicle and Peshastin Irrigation Districts)

Worksheet for Computation of Short Duration Precipitation Magnitude-Frequency Curve

Reference: Technical Note 3, Oct 2009 revision

JTS, 12/09/2016

page 2 of 2

Comparison to PMP for local storm (thunderstorm). Ref: HMR-57, Fig. 11.19 and 11.12, Table 11.4.

$$\begin{aligned} \text{Local storm, 1-hour PMP} &= \text{Input } 6.6 \text{ in.} \\ \text{2-hour PMP} &= 110\% \times 1\text{-hr} = 7.3 \text{ in.} \end{aligned}$$

Frequency / design step :	Step 3	Step 4	Step 5	Step 6	Step 7	Step 8
Scaling precipitation, P _{sd} (in.) :	2.52	2.90	3.32	3.79	4.32	4.90
Percentage of 2-hr PMP (%) :	34.7	39.9	45.8	52.3	59.4	67.5

Note: Per Tech Note 3, page 10: For IDF = PMF, use PMP > Step 6.

Basin average precipitation for large watershed.

$$\text{Drainage area} = 6 \text{ sq.miles. (Compare to small watershed } < 1 \text{ sq.mile.)}$$

$$\begin{aligned} \text{Basin avg. precip} &= 92 \% \text{ of total storm point precip.} \\ &\text{(from } \mathbf{Multipliers} \text{ worksheet)} \end{aligned}$$

Frequency / design step :	10 yr	25 yr	100 yr	Step 1	Step 2	Step 3
Total storm point precip :	1.22	1.41	1.74	2.17	2.38	2.75
Basin avg total storm precip :	1.12	1.30	1.60	2.00	2.19	2.53

Frequency / design step :	Step 4	Step 5	Step 6	Step 7	Step 8	PMP
Total storm point precip :	3.16	3.63	4.14	4.71	5.34	7.92
Basin avg total storm precip :	2.91	3.34	3.81	4.33	4.92	7.29

Peak rainfall intensity for design storm.

$$\text{Peak rainfall intensity (in/hr)} = (\text{total storm precip}) \times (\text{peak intensity factor})$$

$$\begin{aligned} \text{peak intensity factor} &= 2.99172 \text{ for Climatic Region } 14 \\ &\text{(from } \mathbf{Multipliers} \text{ worksheet)} \text{ Hyetograph no. } 6 \end{aligned}$$

Frequency / design step :	10 yr	25 yr	100 yr	Step 1	Step 2	Step 3
Basin avg total storm precip :	1.12	1.30	1.60	2.00	2.19	2.53
Peak storm intensity (in/hr) :	3.34	3.89	4.79	5.98	6.54	7.57

Frequency / design step :	Step 4	Step 5	Step 6	Step 7	Step 8	PMP
Basin avg total storm precip :	2.91	3.34	3.81	4.33	4.92	7.29
Peak storm intensity (in/hr) :	8.71	9.98	11.39	12.96	14.71	21.80

Total storm multipliers for short duration storm hyetographs
MDW, 10/13/09

<u>Regions</u>	<u>Hyetograph</u>	<u>Total storm multiplier</u>	<u>Peak intensity factor</u>
5	5	1.2050	2.23068
151-142	5	1.2050	2.23068
15-154	5	1.2050	2.23068
31-32	5	1.2050	2.23068
14-147-13	6	1.0910	2.99172
77-07	7	1.0350	3.50136

This project :

Region	Hyetograph	Multiplier	Factor
14	6 <i>Input</i>	1.0910 <i>Input</i>	2.99172 <i>Input</i>

Areal adjustment factors for short duration storm hyetographs
MDW, 9/11/09

Basin average precipitation for large watershed.

Refs :

Tech Note 3 (2009 update), Table 1 on page 9
Schaefer, Extreme Storms; Figure 16 on page 70

<u>Drainage area (sq.miles)</u>	<u>Percentage of point precip (%)</u>
< 1	100
1 < 2	100
2 < 3	99
3 < 5	96
5 < 7	92
7 < 10	89
> 10	85

This project :

Drainage area = 6 sq.miles. (Compare to small watershed < 1 sq.mile.)

Basin avg. precip = 92 % of total storm point precip.
Input

Appendix E

Snowmelt Calculation Worksheet

Eightmile Lake (Icicle and Peshastin Irrigation Districts)

Calculate snowmelt during rain-on-snow events

JTS, 02/15/17

page 1
of 4

Snowmelt calculations for sub-basins within Eightmile Lake watershed

References :

Corps of Engineers. **Runoff from Snowmelt**. EM 1110-2-1406. USACE. 1998.
WSDOT. **Hydraulics Manual**. M 23-03. WSDOT. 2010. Section 2-4.1 on pages 2-5 to 2-6.

Key equations:

$\text{Snowmelt} = [(\text{LW rad} + \text{Conv} + \text{rain melt}) (\text{T}_{\text{air}} - 32)]$ $+ [\text{SW rad} + \text{ground melt}]$	<table border="0"> <tr><td>% forest</td><td>k</td><td>SW rad</td></tr> <tr><td>0</td><td>1.0</td><td>0.07</td></tr> <tr><td>10</td><td>1.0</td><td>0.07</td></tr> <tr><td>20</td><td>0.9</td><td>0.07</td></tr> <tr><td>30</td><td>0.8</td><td>0.07</td></tr> <tr><td>40</td><td>0.7</td><td>0.07</td></tr> <tr><td>50</td><td>0.6</td><td>0.07</td></tr> <tr><td>60</td><td>0.5</td><td>0.07</td></tr> <tr><td>70</td><td>0.4</td><td>0.07</td></tr> <tr><td>80</td><td>0.3</td><td>0.05</td></tr> <tr><td>90</td><td>0.3</td><td>0.03</td></tr> <tr><td>100</td><td>0.3</td><td>0.03</td></tr> </table>	% forest	k	SW rad	0	1.0	0.07	10	1.0	0.07	20	0.9	0.07	30	0.8	0.07	40	0.7	0.07	50	0.6	0.07	60	0.5	0.07	70	0.4	0.07	80	0.3	0.05	90	0.3	0.03	100	0.3	0.03
% forest	k	SW rad																																			
0	1.0	0.07																																			
10	1.0	0.07																																			
20	0.9	0.07																																			
30	0.8	0.07																																			
40	0.7	0.07																																			
50	0.6	0.07																																			
60	0.5	0.07																																			
70	0.4	0.07																																			
80	0.3	0.05																																			
90	0.3	0.03																																			
100	0.3	0.03																																			
<p>where : Conv = 0.0084 k V_{air} ; k = f (% forest cover)</p> <p style="padding-left: 40px;">use V_{air} = 18 mph</p> <p style="padding-left: 40px;">checking : 80 % forest cover</p> <p style="padding-left: 40px;">Conv = 0.045 OK</p> <p style="padding-left: 40px;">Rainmelt = 0.007 Pr</p>																																					

coefficients :

	24-hr values :	18-hr values :	72-hr values :
LW rad	0.029 in. / day F	0.022	0.087
Conv	0.0084 in. / day mph F	0.0063	0.0252
rain melt	0.007 in. / in. F	0.007	0.007
SW rad	0.07 in. / day	0.053	0.21
grnd melt	0.02 in. / day	0.015	0.06

Calculation procedure :

- 1) Identify elevation zones in increments of 1000 feet where snow may occur. Determine area and % of sub-basin for each elevation zone.
- 2) Estimate snowpack depth and water content for each elevation zone (represents upper limit for snowmelt runoff).
- 3) Estimate air temperature for highest elevation. Estimate air temperature lapse rate : 5.5 deg F per 1000 feet elevation change. Calculate average air temperature for each elevation zone.
- 4) Estimate R18 and R72 from design precipitation worksheets. Estimate typical wind velocity W from climatological data. If not available, estimate W = 18 mph.
- 5) Calculate M18 and M72 for each elevation zone. Calculate weighted average (weighted by % area) snowmelt depths M18 and M72 for the entire sub-basin.
- 6) Add snowmelt to rainfall to get total storm precipitation available for runoff.

Average January temperature = 26 deg F at Leavenworth, WA
Average March/April temperature 44 deg F at Leavenworth, WA

Eightmile Lake (Icicle and Peshastin Irrigation Districts)

Calculate snowmelt during rain-on-snow events
JTS, 02/15/17

page 2
of 4

Snowmelt calculations for sub-basins within Eightmile Lake watershed

Snowmelt calculations for Eightmile Lake

Sub-basin drainage area =	6 acres / sq.miles					
Highest elevation =	7980 feet	Temperature =	32.0 deg F			
Average wind velocity =	17 miles/hour					
Reservoir elevation =	4670 feet	Temperature =	50.2 deg F			
Zone 1 base elev. =	6500 feet	Average temp. =	36.1 deg F			
Zone 2 base elev. =	5500 feet	Average temp. =	42.9 deg F			
Zone 3 base elev. =	4500 feet	Average temp. =	48.4 deg F			
Frequency/design step:	100 yr	Step 1	Step 5	Step 7	Step 8	
Rainfall :						
Intermediate :	R18 =	6.26	7.59	11.49	13.97	15.31
Long duration:	R72 =	13.21	15.95	23.16	27.27	29.36

Elevation Zone 1 :

Elevations =	6500 feet	to	7980 feet		
Zone drainage area =	1.93 acres / sq.miles	forest cover =	10 % forest		
% of sub-basin =	32.2 %	conv k =	1.0		
Air temperature =	36.1 deg F.	SW rad =	0.07 in. / day		
Snowpack depth =	10.0 feet =	120 inches			
Water content =	20 % =	24.0 inches			

Frequency/design step :	100 yr	Step 1	Step 5	Step 7	Step 8	
Snowmelt (inches):						
Intermediate :	M18 =	0.77	0.81	0.92	0.99	1.03
% of snow water content =		3.2	3.4	3.8	4.1	4.3
revised M18 =		0.77	0.81	0.92	0.99	1.03
weighted M18 =		0.248	0.260	0.296	0.318	0.331
Long duration:	M72 =	2.74	2.82	3.03	3.14	3.20
% of snow water content =		11.4	11.8	12.6	13.1	13.4
revised M72 =		2.74	2.82	3.03	3.14	3.20
weighted M72 =		0.883	0.908	0.974	1.012	1.031

Eightmile Lake (Icicle and Peshastin Irrigation Districts)

Snowmelt calculations for Eightmile Lake

Elevation Zone 2 :

Elevations = 5500 feet to 6500 feet
 Zone drainage area = 2.48 acres / sq.miles forest cover = 50 % forest
 % of sub-basin = 41.3 % conv k = 0.6
 Air temperature = 42.9 deg F. SW rad = 0.07 in. / day
 Snowpack depth = 5.0 feet = 60 inches
 Water content = 20 % = 12.0 inches

Frequency/design step :	100 yr	Step 1	Step 5	Step 7	Step 8	
Snowmelt (inches):						
Intermediate :	M18 =	1.48	1.58	1.88	2.07	2.17
	% of snow water content =	12.3	13.2	15.7	17.2	18.1
	revised M18 =	1.48	1.58	1.88	2.07	2.17
	weighted M18 =	0.612	0.654	0.777	0.855	0.897
Long duration:	M72 =	5.02	5.23	5.78	6.10	6.25
	% of snow water content =	41.9	43.6	48.2	50.8	52.1
	revised M72 =	5.02	5.23	5.78	6.10	6.25
	weighted M72 =	2.076	2.163	2.390	2.519	2.585

Elevation Zone 3 :

Elevations = 4500 feet to 5500 feet
 Zone drainage area = 1.59 acres / sq.miles forest cover = 75 % forest
 % of sub-basin = 26.5 % conv k = 0.4
 Air temperature = 48.4 deg F. SW rad = 0.06 in. / day
 Snowpack depth = 3.0 feet = 36 inches
 Water content = 20 % = 7.2 inches

Frequency/design step :	100 yr	Step 1	Step 5	Step 7	Step 8	
Snowmelt (inches):						
Intermediate :	M18 =	1.75	1.90	2.35	2.63	2.79
	% of snow water content =	24.3	26.4	32.6	36.6	38.7
	revised M18 =	1.75	1.90	2.35	2.63	2.79
	weighted M18 =	0.464	0.504	0.623	0.698	0.739
Long duration:	M72 =	5.64	5.95	6.78	7.25	7.49
	% of snow water content =	78.3	82.7	94.2	100.7	104.1
	revised M72 =	5.64	5.95	6.78	7.20	7.20
	weighted M72 =	1.494	1.578	1.797	1.908	1.908

Eightmile Lake (Icicle and Peshastin Irrigation Districts)

Snowmelt calculations for Eightmile Lake

Snowmelt and design storm precipitation (in inches) for overall sub-basin :

Frequency/design step :		100 yr	Step 1	Step 5	Step 7	Step 8
Intermediate :	M18 =	1.32	1.42	1.70	1.87	1.97
	R18 =	6.26	7.59	11.49	13.97	15.31
	P18 =	7.58	9.01	13.19	15.84	17.28
Long duration:	M72 =	4.45	4.65	5.16	5.44	5.52
	R72 =	13.21	15.95	23.16	27.27	29.36
	P72 =	17.66	20.60	28.32	32.71	34.88

[end for this sub-basin]

Appendix F

HEC-HMS Model Results

Reservoir "Eightmile Lake" Results for Run "Inter8ResSnow"

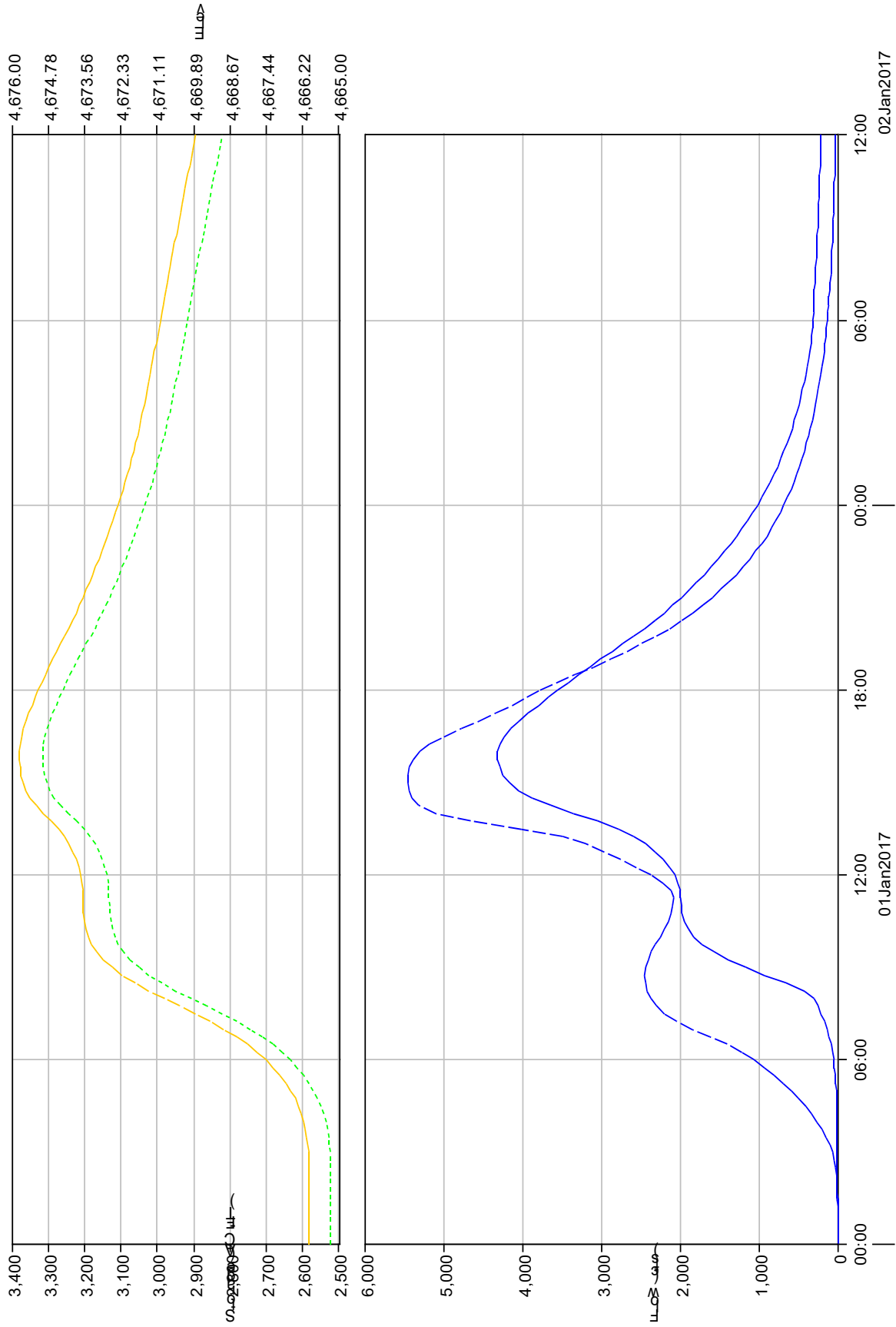

Project: EightmileLake Simulation Run: Inter8ResSnow
Reservoir: Eightmile Lake

Start of Run: 01Jan2017, 00:00 Basin Model: EightmileLkResv
End of Run: 02Jan2017, 12:00 Meteorologic Model: Inter8Snowmelt
Compute Time: 13Apr2017, 07:33:15 Control Specifications: Intermediate

Volume Units: AC-FT

Computed Results

Peak Inflow:	5447.3 (CFS)	Date/Time of Peak Inflow:	01Jan2017, 15:00
Peak Discharge:	4308.4 (CFS)	Date/Time of Peak Discharge:	01Jan2017, 15:45
Inflow Volume:	4462.2 (AC-FT)	Peak Storage:	3314.1 (AC-FT)
Discharge Volume:	3728.7 (AC-FT)	Peak Elevation:	4675.7 (FT)

Project: EightmileLake Simulation Run: Inter8ResSnow
 Reservoir: Eightmile Lake

Start of Run: 01Jan2017, 00:00 Basin Model: EightmileLkResv
 End of Run: 02Jan2017, 12:00 Meteorologic Model: Inter8Snowmelt
 Compute Time: 13Apr2017, 07:33:15 Control Specifications:Intermediate

Date	Time	Inflow (CFS)	Storage (AC-FT)	Elevation (FT)	Outflow (CFS)
01Jan2017	00:00	0.0	2522.6	4666.0	0.0
01Jan2017	00:15	0.0	2522.6	4666.0	0.0
01Jan2017	00:30	0.0	2522.6	4666.0	0.0
01Jan2017	00:45	0.0	2522.6	4666.0	0.0
01Jan2017	01:00	0.0	2522.6	4666.0	0.0
01Jan2017	01:15	0.0	2522.6	4666.0	0.0
01Jan2017	01:30	0.0	2522.6	4666.0	0.0
01Jan2017	01:45	0.2	2522.6	4666.0	0.0
01Jan2017	02:00	1.5	2522.6	4666.0	0.0
01Jan2017	02:15	6.3	2522.7	4666.0	0.0
01Jan2017	02:30	17.2	2522.9	4666.0	0.0
01Jan2017	02:45	35.4	2523.5	4666.0	0.0
01Jan2017	03:00	61.4	2524.5	4666.0	0.1
01Jan2017	03:15	95.6	2526.1	4666.0	0.3
01Jan2017	03:30	139.0	2528.5	4666.1	0.6
01Jan2017	03:45	192.8	2531.9	4666.1	1.2
01Jan2017	04:00	255.7	2536.5	4666.2	2.1
01Jan2017	04:15	326.5	2542.4	4666.3	3.6
01Jan2017	04:30	405.7	2549.9	4666.4	5.9
01Jan2017	04:45	493.5	2559.1	4666.5	9.0
01Jan2017	05:00	589.8	2570.0	4666.6	13.3
01Jan2017	05:15	693.9	2582.9	4666.8	19.1
01Jan2017	05:30	805.2	2598.0	4667.0	26.6
01Jan2017	05:45	925.4	2615.2	4667.2	36.1
01Jan2017	06:00	1060.1	2634.8	4667.5	48.0
01Jan2017	06:15	1214.5	2657.2	4667.7	62.8

Date	Time	Inflow (CFS)	Storage (AC-FT)	Elevation (FT)	Outflow (CFS)
01Jan2017	06:30	1395.6	2682.7	4668.1	81.2
01Jan2017	06:45	1614.2	2711.8	4668.4	103.9
01Jan2017	07:00	1845.2	2745.2	4668.9	131.9
01Jan2017	07:15	2041.4	2782.2	4669.3	165.4
01Jan2017	07:30	2189.0	2822.1	4669.8	204.0
01Jan2017	07:45	2294.8	2863.8	4670.3	246.7
01Jan2017	08:00	2367.5	2906.4	4670.9	292.7
01Jan2017	08:15	2414.1	2948.6	4671.4	423.7
01Jan2017	08:30	2438.5	2987.6	4671.9	659.3
01Jan2017	08:45	2442.3	3021.8	4672.3	917.5
01Jan2017	09:00	2429.9	3050.6	4672.6	1165.1
01Jan2017	09:15	2403.8	3074.1	4672.9	1385.5
01Jan2017	09:30	2362.6	3092.8	4673.1	1570.5
01Jan2017	09:45	2308.3	3107.0	4673.3	1717.0
01Jan2017	10:00	2249.0	3117.1	4673.4	1824.2
01Jan2017	10:15	2194.4	3123.8	4673.5	1896.8
01Jan2017	10:30	2148.7	3128.0	4673.6	1942.5
01Jan2017	10:45	2112.1	3130.4	4673.6	1968.9
01Jan2017	11:00	2086.9	3131.7	4673.6	1982.7
01Jan2017	11:15	2079.8	3132.3	4673.6	1989.8
01Jan2017	11:30	2116.9	3133.1	4673.6	1998.2
01Jan2017	11:45	2216.3	3134.9	4673.6	2018.0
01Jan2017	12:00	2366.2	3138.4	4673.7	2058.0
01Jan2017	12:15	2549.9	3144.1	4673.7	2121.6
01Jan2017	12:30	2754.2	3151.7	4673.8	2208.4
01Jan2017	12:45	2966.1	3161.0	4674.0	2315.8
01Jan2017	13:00	3192.8	3171.6	4674.1	2440.6
01Jan2017	13:15	3480.2	3183.8	4674.2	2585.9
01Jan2017	13:30	4009.4	3199.5	4674.4	2778.7
01Jan2017	13:45	4656.5	3220.6	4674.7	3044.1
01Jan2017	14:00	5096.0	3244.5	4674.9	3353.1

Date	Time	Inflow (CFS)	Storage (AC-FT)	Elevation (FT)	Outflow (CFS)
01Jan2017	14:15	5314.1	3266.1	4675.2	3642.4
01Jan2017	14:30	5396.3	3283.2	4675.4	3875.5
01Jan2017	14:45	5430.1	3295.4	4675.5	4044.2
01Jan2017	15:00	5447.3	3303.6	4675.6	4160.6
01Jan2017	15:15	5446.8	3309.1	4675.7	4238.1
01Jan2017	15:30	5426.4	3312.5	4675.7	4285.6
01Jan2017	15:45	5383.7	3314.1	4675.7	4308.4
01Jan2017	16:00	5302.1	3314.0	4675.7	4308.0
01Jan2017	16:15	5172.0	3312.2	4675.7	4282.2
01Jan2017	16:30	4990.4	3308.4	4675.7	4228.2
01Jan2017	16:45	4771.8	3302.6	4675.6	4145.9
01Jan2017	17:00	4548.4	3295.1	4675.5	4040.6
01Jan2017	17:15	4334.0	3286.5	4675.4	3921.2
01Jan2017	17:30	4133.9	3277.4	4675.3	3795.7
01Jan2017	17:45	3945.9	3268.1	4675.2	3669.1
01Jan2017	18:00	3767.4	3258.8	4675.1	3544.2
01Jan2017	18:15	3569.1	3249.5	4675.0	3419.2
01Jan2017	18:30	3336.3	3239.5	4674.9	3287.6
01Jan2017	18:45	3099.3	3228.7	4674.7	3147.5
01Jan2017	19:00	2875.4	3217.4	4674.6	3002.4
01Jan2017	19:15	2667.7	3205.8	4674.5	2857.2
01Jan2017	19:30	2475.4	3194.4	4674.3	2714.9
01Jan2017	19:45	2297.8	3183.1	4674.2	2577.6
01Jan2017	20:00	2133.6	3172.1	4674.1	2446.0
01Jan2017	20:15	1981.7	3161.5	4674.0	2320.9
01Jan2017	20:30	1841.1	3151.2	4673.8	2201.9
01Jan2017	20:45	1711.0	3141.2	4673.7	2089.2
01Jan2017	21:00	1590.7	3131.6	4673.6	1982.3
01Jan2017	21:15	1479.2	3122.4	4673.5	1880.9
01Jan2017	21:30	1376.1	3113.4	4673.4	1784.3
01Jan2017	21:45	1280.6	3104.6	4673.3	1692.4

Date	Time	Inflow (CFS)	Storage (AC-FT)	Elevation (FT)	Outflow (CFS)
01Jan2017	22:00	1192.1	3096.1	4673.2	1603.9
01Jan2017	22:15	1110.1	3087.6	4673.1	1518.2
01Jan2017	22:30	1034.1	3079.2	4673.0	1435.3
01Jan2017	22:45	963.5	3071.0	4672.9	1355.8
01Jan2017	23:00	898.0	3063.0	4672.8	1279.9
01Jan2017	23:15	837.3	3055.3	4672.7	1207.8
01Jan2017	23:30	780.8	3047.7	4672.6	1139.6
01Jan2017	23:45	728.2	3040.4	4672.5	1075.1
02Jan2017	00:00	679.3	3033.4	4672.4	1014.3
02Jan2017	00:15	633.8	3026.6	4672.3	957.1
02Jan2017	00:30	591.4	3020.0	4672.3	903.3
02Jan2017	00:45	551.9	3013.7	4672.2	852.6
02Jan2017	01:00	515.1	3007.6	4672.1	805.1
02Jan2017	01:15	480.9	3001.7	4672.0	760.6
02Jan2017	01:30	448.8	2996.0	4672.0	718.8
02Jan2017	01:45	418.7	2990.5	4671.9	679.6
02Jan2017	02:00	390.4	2985.2	4671.8	642.8
02Jan2017	02:15	364.1	2980.1	4671.8	608.4
02Jan2017	02:30	339.6	2975.1	4671.7	576.1
02Jan2017	02:45	316.9	2970.3	4671.7	545.8
02Jan2017	03:00	295.7	2965.7	4671.6	517.6
02Jan2017	03:15	275.7	2961.2	4671.5	491.2
02Jan2017	03:30	257.0	2956.8	4671.5	466.6
02Jan2017	03:45	239.5	2952.5	4671.4	443.5
02Jan2017	04:00	222.9	2948.3	4671.4	422.1
02Jan2017	04:15	207.9	2944.3	4671.3	402.3
02Jan2017	04:30	194.0	2940.3	4671.3	383.9
02Jan2017	04:45	181.1	2936.4	4671.2	367.1
02Jan2017	05:00	169.1	2932.6	4671.2	351.7
02Jan2017	05:15	157.8	2928.9	4671.2	337.7
02Jan2017	05:30	147.2	2925.2	4671.1	325.3

Date	Time	Inflow (CFS)	Storage (AC-FT)	Elevation (FT)	Outflow (CFS)
02Jan2017	05:45	137.4	2921.5	4671.1	314.7
02Jan2017	06:00	128.2	2917.8	4671.0	306.2
02Jan2017	06:15	119.6	2914.1	4671.0	301.4
02Jan2017	06:30	111.6	2910.3	4670.9	297.1
02Jan2017	06:45	104.2	2906.4	4670.9	292.8
02Jan2017	07:00	97.2	2902.5	4670.8	288.5
02Jan2017	07:15	90.6	2898.5	4670.8	284.1
02Jan2017	07:30	84.6	2894.5	4670.7	279.7
02Jan2017	07:45	78.9	2890.5	4670.7	275.3
02Jan2017	08:00	73.7	2886.4	4670.6	270.9
02Jan2017	08:15	68.8	2882.3	4670.6	266.5
02Jan2017	08:30	64.2	2878.3	4670.5	262.1
02Jan2017	08:45	59.9	2874.2	4670.5	257.7
02Jan2017	09:00	55.8	2870.1	4670.4	253.3
02Jan2017	09:15	52.0	2866.0	4670.4	249.0
02Jan2017	09:30	48.3	2861.9	4670.3	244.7
02Jan2017	09:45	44.5	2857.9	4670.3	240.5
02Jan2017	10:00	41.2	2853.8	4670.2	236.3
02Jan2017	10:15	37.9	2849.8	4670.2	232.1
02Jan2017	10:30	34.9	2845.8	4670.1	228.0
02Jan2017	10:45	32.2	2841.8	4670.1	223.9
02Jan2017	11:00	29.7	2837.9	4670.0	219.9
02Jan2017	11:15	27.4	2834.0	4670.0	215.9
02Jan2017	11:30	25.2	2830.1	4669.9	212.0
02Jan2017	11:45	23.2	2826.3	4669.9	208.1
02Jan2017	12:00	21.2	2822.5	4669.8	204.3

Reservoir "Eightmile Lake" Results for Run "Long8ResSnow"

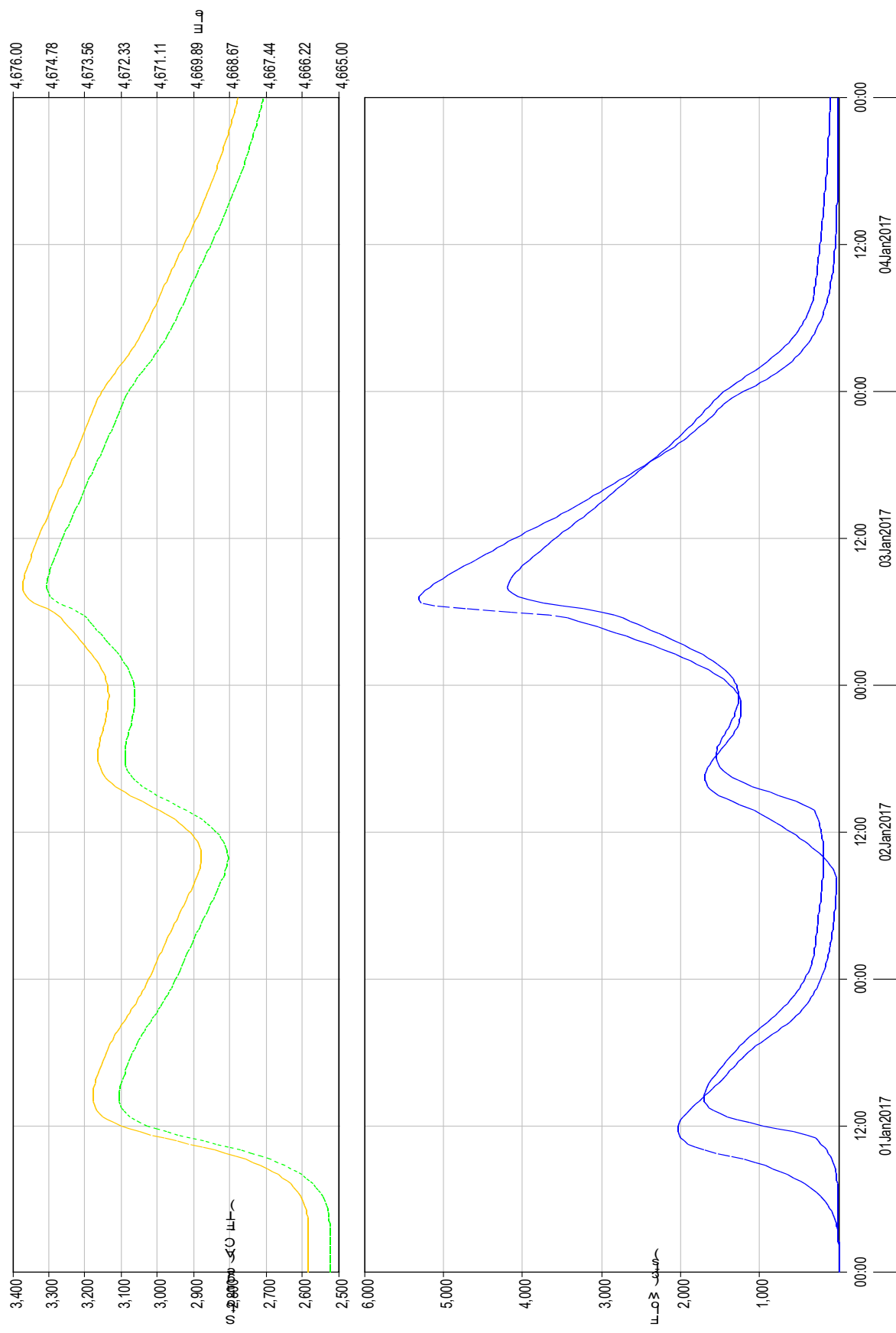

Project: EightmileLake Simulation Run: Long8ResSnow
Reservoir: Eightmile Lake

Start of Run: 01Jan2017, 00:00 Basin Model: EightmileLkResv
End of Run: 05Jan2017, 00:00 Meteorologic Model: Long 8 Snowmelt
Compute Time: 13Apr2017, 07:33:39 Control Specifications: LongStep8Res

Volume Units: AC-FT

Computed Results

Peak Inflow: 5315.3 (CFS)	Date/Time of Peak Inflow: 03Jan2017, 07:00
Peak Discharge: 4183.5 (CFS)	Date/Time of Peak Discharge: 03Jan2017, 08:00
Inflow Volume: 9534.6 (AC-FT)	Peak Storage: 3305.3 (AC-FT)
Discharge Volume: 8641.0 (AC-FT)	Peak Elevation: 4675.6 (FT)

Project: EightmileLake Simulation Run: Long8ResSnow
 Reservoir: Eightmile Lake

Start of Run: 01Jan2017, 00:00 Basin Model: EightmileLkResv
 End of Run: 05Jan2017, 00:00 Meteorologic Model: Long 8 Snowmelt
 Compute Time: 13Apr2017, 07:33:39 Control Specifications:LongStep8Res

Date	Time	Inflow (CFS)	Storage (AC-FT)	Elevation (FT)	Outflow (CFS)
01Jan2017	00:00	0.0	2522.6	4666.0	0.0
01Jan2017	00:15	0.0	2522.6	4666.0	0.0
01Jan2017	00:30	0.0	2522.6	4666.0	0.0
01Jan2017	00:45	0.0	2522.6	4666.0	0.0
01Jan2017	01:00	0.0	2522.6	4666.0	0.0
01Jan2017	01:15	0.0	2522.6	4666.0	0.0
01Jan2017	01:30	0.0	2522.6	4666.0	0.0
01Jan2017	01:45	0.0	2522.6	4666.0	0.0
01Jan2017	02:00	0.0	2522.6	4666.0	0.0
01Jan2017	02:15	0.0	2522.6	4666.0	0.0
01Jan2017	02:30	0.0	2522.6	4666.0	0.0
01Jan2017	02:45	0.2	2522.6	4666.0	0.0
01Jan2017	03:00	1.1	2522.6	4666.0	0.0
01Jan2017	03:15	3.7	2522.6	4666.0	0.0
01Jan2017	03:30	8.7	2522.8	4666.0	0.0
01Jan2017	03:45	16.1	2523.0	4666.0	0.0
01Jan2017	04:00	26.0	2523.5	4666.0	0.0
01Jan2017	04:15	38.6	2524.1	4666.0	0.1
01Jan2017	04:30	53.4	2525.1	4666.0	0.2
01Jan2017	04:45	69.8	2526.3	4666.0	0.3
01Jan2017	05:00	88.3	2528.0	4666.1	0.5
01Jan2017	05:15	109.7	2530.0	4666.1	0.8
01Jan2017	05:30	134.5	2532.5	4666.1	1.3
01Jan2017	05:45	163.1	2535.5	4666.2	1.9
01Jan2017	06:00	195.6	2539.2	4666.2	2.8
01Jan2017	06:15	232.0	2543.5	4666.3	3.9

Date	Time	Inflow (CFS)	Storage (AC-FT)	Elevation (FT)	Outflow (CFS)
01Jan2017	06:30	272.2	2548.6	4666.3	5.5
01Jan2017	06:45	317.8	2554.6	4666.4	7.4
01Jan2017	07:00	369.8	2561.5	4666.5	9.9
01Jan2017	07:15	428.7	2569.5	4666.6	13.1
01Jan2017	07:30	494.5	2578.8	4666.7	17.2
01Jan2017	07:45	567.0	2589.3	4666.9	22.2
01Jan2017	08:00	646.1	2601.3	4667.0	28.4
01Jan2017	08:15	731.7	2614.9	4667.2	35.9
01Jan2017	08:30	825.7	2630.2	4667.4	45.1
01Jan2017	08:45	931.7	2647.3	4667.6	56.1
01Jan2017	09:00	1053.5	2666.5	4667.9	69.4
01Jan2017	09:15	1200.2	2688.2	4668.1	85.3
01Jan2017	09:30	1368.6	2712.7	4668.5	104.7
01Jan2017	09:45	1541.7	2740.4	4668.8	127.8
01Jan2017	10:00	1696.5	2770.9	4669.2	155.0
01Jan2017	10:15	1815.1	2803.7	4669.6	185.9
01Jan2017	10:30	1899.4	2837.9	4670.0	219.8
01Jan2017	10:45	1956.9	2872.8	4670.5	256.2
01Jan2017	11:00	1994.4	2907.9	4670.9	294.5
01Jan2017	11:15	2018.2	2942.5	4671.3	393.9
01Jan2017	11:30	2031.1	2974.4	4671.7	571.2
01Jan2017	11:45	2034.2	3002.6	4672.1	767.0
01Jan2017	12:00	2028.3	3026.7	4672.3	958.0
01Jan2017	12:15	2013.7	3046.8	4672.6	1131.7
01Jan2017	12:30	1991.0	3063.3	4672.8	1282.0
01Jan2017	12:45	1960.7	3076.3	4672.9	1406.7
01Jan2017	13:00	1926.2	3086.4	4673.1	1505.9
01Jan2017	13:15	1889.3	3093.9	4673.2	1581.7
01Jan2017	13:30	1850.7	3099.3	4673.2	1636.8
01Jan2017	13:45	1810.3	3102.8	4673.3	1673.9
01Jan2017	14:00	1768.5	3104.9	4673.3	1695.3

Date	Time	Inflow (CFS)	Storage (AC-FT)	Elevation (FT)	Outflow (CFS)
01Jan2017	14:15	1725.1	3105.7	4673.3	1704.1
01Jan2017	14:30	1680.2	3105.6	4673.3	1702.4
01Jan2017	14:45	1636.9	3104.7	4673.3	1692.6
01Jan2017	15:00	1596.6	3103.1	4673.3	1677.0
01Jan2017	15:15	1556.8	3101.2	4673.2	1657.0
01Jan2017	15:30	1515.5	3098.9	4673.2	1633.5
01Jan2017	15:45	1475.5	3096.4	4673.2	1607.0
01Jan2017	16:00	1438.2	3093.6	4673.1	1578.4
01Jan2017	16:15	1403.7	3090.6	4673.1	1548.5
01Jan2017	16:30	1369.2	3087.6	4673.1	1518.1
01Jan2017	16:45	1332.9	3084.5	4673.0	1486.9
01Jan2017	17:00	1297.2	3081.2	4673.0	1455.0
01Jan2017	17:15	1260.8	3077.9	4673.0	1422.6
01Jan2017	17:30	1222.7	3074.5	4672.9	1389.5
01Jan2017	17:45	1182.3	3071.0	4672.9	1355.6
01Jan2017	18:00	1139.9	3067.4	4672.8	1320.7
01Jan2017	18:15	1095.6	3063.5	4672.8	1284.7
01Jan2017	18:30	1046.7	3059.5	4672.7	1247.1
01Jan2017	18:45	994.5	3055.2	4672.7	1207.7
01Jan2017	19:00	940.6	3050.7	4672.6	1166.4
01Jan2017	19:15	885.5	3045.9	4672.6	1123.4
01Jan2017	19:30	829.5	3040.9	4672.5	1079.0
01Jan2017	19:45	772.5	3035.6	4672.5	1033.3
01Jan2017	20:00	717.5	3030.1	4672.4	986.7
01Jan2017	20:15	666.1	3024.5	4672.3	940.0
01Jan2017	20:30	618.4	3018.9	4672.2	893.7
01Jan2017	20:45	574.4	3013.2	4672.2	848.5
01Jan2017	21:00	533.6	3007.5	4672.1	804.7
01Jan2017	21:15	495.8	3002.0	4672.0	762.6
01Jan2017	21:30	460.8	2996.5	4672.0	722.4
01Jan2017	21:45	428.3	2991.2	4671.9	684.1

Date	Time	Inflow (CFS)	Storage (AC-FT)	Elevation (FT)	Outflow (CFS)
01Jan2017	22:00	398.2	2986.0	4671.8	647.7
01Jan2017	22:15	370.3	2980.9	4671.8	613.4
01Jan2017	22:30	344.5	2975.9	4671.7	581.0
01Jan2017	22:45	320.5	2971.1	4671.7	550.5
01Jan2017	23:00	298.3	2966.4	4671.6	521.9
01Jan2017	23:15	277.6	2961.9	4671.6	495.1
01Jan2017	23:30	258.4	2957.4	4671.5	470.1
01Jan2017	23:45	240.6	2953.1	4671.4	446.7
02Jan2017	00:00	224.0	2948.9	4671.4	425.0
02Jan2017	00:15	208.7	2944.8	4671.3	404.8
02Jan2017	00:30	194.4	2940.8	4671.3	386.2
02Jan2017	00:45	181.2	2936.9	4671.2	369.0
02Jan2017	01:00	169.0	2933.0	4671.2	353.3
02Jan2017	01:15	157.6	2929.2	4671.2	339.1
02Jan2017	01:30	146.9	2925.5	4671.1	326.5
02Jan2017	01:45	137.1	2921.8	4671.1	315.5
02Jan2017	02:00	127.8	2918.1	4671.0	306.8
02Jan2017	02:15	119.2	2914.4	4671.0	301.7
02Jan2017	02:30	111.2	2910.6	4670.9	297.4
02Jan2017	02:45	103.7	2906.7	4670.9	293.1
02Jan2017	03:00	96.7	2902.8	4670.8	288.7
02Jan2017	03:15	90.2	2898.8	4670.8	284.4
02Jan2017	03:30	84.1	2894.7	4670.7	279.9
02Jan2017	03:45	78.4	2890.7	4670.7	275.5
02Jan2017	04:00	73.1	2886.6	4670.6	271.1
02Jan2017	04:15	68.1	2882.5	4670.6	266.6
02Jan2017	04:30	63.5	2878.4	4670.5	262.2
02Jan2017	04:45	59.2	2874.3	4670.5	257.8
02Jan2017	05:00	55.1	2870.2	4670.4	253.5
02Jan2017	05:15	51.3	2866.1	4670.4	249.1
02Jan2017	05:30	47.7	2862.0	4670.3	244.8

Date	Time	Inflow (CFS)	Storage (AC-FT)	Elevation (FT)	Outflow (CFS)
02Jan2017	05:45	44.3	2858.0	4670.3	240.6
02Jan2017	06:00	41.1	2853.9	4670.2	236.3
02Jan2017	06:15	38.2	2849.9	4670.2	232.2
02Jan2017	06:30	35.4	2845.9	4670.1	228.0
02Jan2017	06:45	32.8	2841.9	4670.1	224.0
02Jan2017	07:00	30.4	2838.0	4670.0	220.0
02Jan2017	07:15	28.2	2834.1	4670.0	216.0
02Jan2017	07:30	26.2	2830.2	4669.9	212.1
02Jan2017	07:45	24.2	2826.4	4669.9	208.3
02Jan2017	08:00	24.9	2822.7	4669.8	204.5
02Jan2017	08:15	29.8	2819.0	4669.8	200.9
02Jan2017	08:30	39.6	2815.6	4669.8	197.5
02Jan2017	08:45	54.1	2812.6	4669.7	194.5
02Jan2017	09:00	72.8	2809.9	4669.7	191.9
02Jan2017	09:15	98.2	2807.7	4669.7	189.8
02Jan2017	09:30	128.7	2806.1	4669.6	188.2
02Jan2017	09:45	162.7	2805.3	4669.6	187.4
02Jan2017	10:00	199.5	2805.1	4669.6	187.3
02Jan2017	10:15	238.8	2805.8	4669.6	187.9
02Jan2017	10:30	283.1	2807.3	4669.6	189.4
02Jan2017	10:45	331.1	2809.7	4669.7	191.7
02Jan2017	11:00	381.3	2813.1	4669.7	195.0
02Jan2017	11:15	433.0	2817.4	4669.8	199.3
02Jan2017	11:30	486.2	2822.7	4669.8	204.6
02Jan2017	11:45	543.4	2829.1	4669.9	210.9
02Jan2017	12:00	603.5	2836.5	4670.0	218.4
02Jan2017	12:15	664.9	2845.0	4670.1	227.1
02Jan2017	12:30	727.1	2854.6	4670.2	237.0
02Jan2017	12:45	789.9	2865.2	4670.4	248.2
02Jan2017	13:00	856.3	2877.0	4670.5	260.7
02Jan2017	13:15	925.0	2889.9	4670.7	274.6

Date	Time	Inflow (CFS)	Storage (AC-FT)	Elevation (FT)	Outflow (CFS)
02Jan2017	13:30	994.4	2903.8	4670.8	289.9
02Jan2017	13:45	1069.9	2919.0	4671.0	308.6
02Jan2017	14:00	1154.8	2935.1	4671.2	361.5
02Jan2017	14:15	1246.3	2951.6	4671.4	439.0
02Jan2017	14:30	1339.5	2968.3	4671.6	533.3
02Jan2017	14:45	1428.8	2984.8	4671.8	639.6
02Jan2017	15:00	1509.2	3000.7	4672.0	753.3
02Jan2017	15:15	1576.1	3015.8	4672.2	869.5
02Jan2017	15:30	1625.0	3029.7	4672.4	983.3
02Jan2017	15:45	1655.0	3042.2	4672.5	1090.4
02Jan2017	16:00	1673.0	3053.0	4672.7	1187.4
02Jan2017	16:15	1683.4	3062.3	4672.8	1272.9
02Jan2017	16:30	1684.8	3070.0	4672.9	1346.1
02Jan2017	16:45	1679.2	3076.3	4672.9	1407.0
02Jan2017	17:00	1668.4	3081.3	4673.0	1456.1
02Jan2017	17:15	1650.3	3085.1	4673.0	1493.8
02Jan2017	17:30	1626.5	3087.9	4673.1	1520.8
02Jan2017	17:45	1602.0	3089.6	4673.1	1538.4
02Jan2017	18:00	1575.9	3090.6	4673.1	1547.9
02Jan2017	18:15	1547.2	3090.8	4673.1	1550.5
02Jan2017	18:30	1515.5	3090.4	4673.1	1546.9
02Jan2017	18:45	1481.0	3089.5	4673.1	1537.7
02Jan2017	19:00	1446.9	3088.2	4673.1	1523.8
02Jan2017	19:15	1415.0	3086.4	4673.1	1506.4
02Jan2017	19:30	1385.5	3084.4	4673.0	1486.6
02Jan2017	19:45	1358.4	3082.3	4673.0	1465.4
02Jan2017	20:00	1333.5	3080.0	4673.0	1443.3
02Jan2017	20:15	1310.6	3077.8	4673.0	1421.0
02Jan2017	20:30	1289.5	3075.5	4672.9	1398.9
02Jan2017	20:45	1270.0	3073.3	4672.9	1377.2
02Jan2017	21:00	1255.1	3071.1	4672.9	1356.4

Date	Time	Inflow (CFS)	Storage (AC-FT)	Elevation (FT)	Outflow (CFS)
02Jan2017	21:15	1246.1	3069.1	4672.9	1337.4
02Jan2017	21:30	1240.3	3067.3	4672.8	1320.5
02Jan2017	21:45	1235.4	3065.8	4672.8	1305.8
02Jan2017	22:00	1231.0	3064.4	4672.8	1292.9
02Jan2017	22:15	1230.0	3063.2	4672.8	1281.9
02Jan2017	22:30	1233.9	3062.3	4672.8	1273.1
02Jan2017	22:45	1242.8	3061.6	4672.8	1267.0
02Jan2017	23:00	1256.5	3061.3	4672.8	1263.9
02Jan2017	23:15	1274.5	3061.3	4672.8	1264.2
02Jan2017	23:30	1299.7	3061.8	4672.8	1268.2
02Jan2017	23:45	1333.2	3062.7	4672.8	1276.7
03Jan2017	00:00	1371.9	3064.1	4672.8	1290.1
03Jan2017	00:15	1413.7	3066.0	4672.8	1308.3
03Jan2017	00:30	1460.8	3068.5	4672.8	1331.3
03Jan2017	00:45	1514.7	3071.4	4672.9	1359.5
03Jan2017	01:00	1575.4	3074.9	4672.9	1393.1
03Jan2017	01:15	1642.3	3079.0	4673.0	1432.6
03Jan2017	01:30	1715.1	3083.6	4673.0	1478.1
03Jan2017	01:45	1793.3	3088.7	4673.1	1529.7
03Jan2017	02:00	1876.6	3094.4	4673.2	1587.4
03Jan2017	02:15	1964.5	3100.7	4673.2	1651.2
03Jan2017	02:30	2056.7	3107.3	4673.3	1719.9
03Jan2017	02:45	2153.0	3114.1	4673.4	1792.6
03Jan2017	03:00	2253.0	3121.2	4673.5	1868.7
03Jan2017	03:15	2356.5	3128.5	4673.6	1947.4
03Jan2017	03:30	2463.2	3135.8	4673.7	2028.5
03Jan2017	03:45	2573.1	3143.2	4673.7	2111.7
03Jan2017	04:00	2685.9	3150.7	4673.8	2196.5
03Jan2017	04:15	2801.2	3158.2	4673.9	2282.9
03Jan2017	04:30	2919.0	3165.7	4674.0	2370.6
03Jan2017	04:45	3039.1	3173.2	4674.1	2459.3

Date	Time	Inflow (CFS)	Storage (AC-FT)	Elevation (FT)	Outflow (CFS)
03Jan2017	05:00	3161.3	3180.7	4674.2	2549.2
03Jan2017	05:15	3285.4	3188.2	4674.3	2640.0
03Jan2017	05:30	3430.6	3195.9	4674.4	2733.5
03Jan2017	05:45	3664.3	3204.5	4674.5	2840.9
03Jan2017	06:00	4137.3	3216.7	4674.6	2994.0
03Jan2017	06:15	4716.5	3234.2	4674.8	3218.6
03Jan2017	06:30	5105.3	3254.2	4675.0	3482.4
03Jan2017	06:45	5276.7	3272.5	4675.3	3729.4
03Jan2017	07:00	5315.3	3286.4	4675.4	3919.6
03Jan2017	07:15	5302.1	3295.6	4675.5	4048.3
03Jan2017	07:30	5268.7	3301.2	4675.6	4126.6
03Jan2017	07:45	5224.8	3304.2	4675.6	4168.1
03Jan2017	08:00	5173.5	3305.3	4675.6	4183.5
03Jan2017	08:15	5119.2	3305.1	4675.6	4180.7
03Jan2017	08:30	5063.7	3304.0	4675.6	4165.8
03Jan2017	08:45	5004.2	3302.4	4675.6	4142.4
03Jan2017	09:00	4939.2	3300.2	4675.6	4112.6
03Jan2017	09:15	4872.0	3297.7	4675.6	4077.6
03Jan2017	09:30	4804.4	3295.0	4675.5	4039.1
03Jan2017	09:45	4733.6	3292.0	4675.5	3997.9
03Jan2017	10:00	4661.2	3288.9	4675.5	3954.2
03Jan2017	10:15	4588.8	3285.6	4675.4	3908.9
03Jan2017	10:30	4516.6	3282.3	4675.4	3862.5
03Jan2017	10:45	4448.0	3278.9	4675.3	3815.8
03Jan2017	11:00	4381.1	3275.5	4675.3	3769.5
03Jan2017	11:15	4311.1	3272.1	4675.3	3723.4
03Jan2017	11:30	4239.4	3268.7	4675.2	3676.6
03Jan2017	11:45	4167.4	3265.2	4675.2	3629.2
03Jan2017	12:00	4095.4	3261.6	4675.1	3581.5
03Jan2017	12:15	4023.6	3258.0	4675.1	3533.4
03Jan2017	12:30	3948.5	3254.4	4675.1	3484.8

Date	Time	Inflow (CFS)	Storage (AC-FT)	Elevation (FT)	Outflow (CFS)
03Jan2017	12:45	3871.9	3250.7	4675.0	3435.2
03Jan2017	13:00	3795.2	3246.9	4675.0	3384.7
03Jan2017	13:15	3718.9	3243.0	4674.9	3333.7
03Jan2017	13:30	3646.1	3239.1	4674.9	3282.7
03Jan2017	13:45	3575.1	3235.2	4674.8	3232.4
03Jan2017	14:00	3504.4	3231.4	4674.8	3182.6
03Jan2017	14:15	3433.7	3227.6	4674.7	3133.2
03Jan2017	14:30	3362.8	3223.7	4674.7	3084.0
03Jan2017	14:45	3294.9	3219.9	4674.6	3035.2
03Jan2017	15:00	3228.4	3216.2	4674.6	2987.1
03Jan2017	15:15	3161.8	3212.4	4674.6	2939.7
03Jan2017	15:30	3094.8	3208.6	4674.5	2892.5
03Jan2017	15:45	3027.2	3204.9	4674.5	2845.4
03Jan2017	16:00	2962.3	3201.1	4674.4	2798.5
03Jan2017	16:15	2898.6	3197.4	4674.4	2752.1
03Jan2017	16:30	2834.6	3193.6	4674.3	2706.2
03Jan2017	16:45	2769.8	3189.9	4674.3	2660.4
03Jan2017	17:00	2704.3	3186.1	4674.2	2614.5
03Jan2017	17:15	2638.1	3182.3	4674.2	2568.2
03Jan2017	17:30	2571.3	3178.4	4674.2	2521.6
03Jan2017	17:45	2507.0	3174.5	4674.1	2474.8
03Jan2017	18:00	2443.7	3170.6	4674.1	2428.4
03Jan2017	18:15	2379.7	3166.7	4674.0	2382.0
03Jan2017	18:30	2318.1	3162.7	4674.0	2335.9
03Jan2017	18:45	2257.5	3158.8	4673.9	2290.1
03Jan2017	19:00	2196.4	3154.9	4673.9	2244.6
03Jan2017	19:15	2137.6	3151.0	4673.8	2199.5
03Jan2017	19:30	2082.5	3147.1	4673.8	2155.2
03Jan2017	19:45	2028.2	3143.2	4673.7	2111.8
03Jan2017	20:00	1972.7	3139.4	4673.7	2068.8
03Jan2017	20:15	1918.9	3135.6	4673.6	2026.3

Date	Time	Inflow (CFS)	Storage (AC-FT)	Elevation (FT)	Outflow (CFS)
03Jan2017	20:30	1868.3	3131.8	4673.6	1984.4
03Jan2017	20:45	1821.6	3128.1	4673.6	1943.7
03Jan2017	21:00	1775.4	3124.5	4673.5	1904.1
03Jan2017	21:15	1727.6	3120.9	4673.5	1865.1
03Jan2017	21:30	1681.0	3117.3	4673.4	1826.4
03Jan2017	21:45	1637.1	3113.7	4673.4	1788.3
03Jan2017	22:00	1596.4	3110.2	4673.3	1751.0
03Jan2017	22:15	1558.6	3106.8	4673.3	1714.8
03Jan2017	22:30	1523.5	3103.4	4673.3	1679.7
03Jan2017	22:45	1487.7	3100.1	4673.2	1645.5
03Jan2017	23:00	1446.5	3096.8	4673.2	1611.1
03Jan2017	23:15	1397.8	3093.2	4673.1	1575.1
03Jan2017	23:30	1341.6	3089.4	4673.1	1536.3
03Jan2017	23:45	1278.5	3085.2	4673.0	1493.9
04Jan2017	00:00	1209.1	3080.5	4673.0	1447.5
04Jan2017	00:15	1134.0	3075.3	4672.9	1396.9
04Jan2017	00:30	1056.6	3069.6	4672.9	1342.3
04Jan2017	00:45	981.9	3063.5	4672.8	1284.7
04Jan2017	01:00	912.1	3057.2	4672.7	1225.5
04Jan2017	01:15	847.4	3050.6	4672.6	1165.9
04Jan2017	01:30	787.4	3044.1	4672.6	1107.0
04Jan2017	01:45	731.9	3037.5	4672.5	1049.4
04Jan2017	02:00	680.3	3031.0	4672.4	993.7
04Jan2017	02:15	632.2	3024.5	4672.3	940.1
04Jan2017	02:30	587.8	3018.3	4672.2	888.9
04Jan2017	02:45	546.5	3012.1	4672.2	840.1
04Jan2017	03:00	508.4	3006.1	4672.1	793.9
04Jan2017	03:15	473.1	3000.3	4672.0	750.2
04Jan2017	03:30	440.4	2994.7	4672.0	709.0
04Jan2017	03:45	410.0	2989.2	4671.9	670.2
04Jan2017	04:00	381.8	2983.9	4671.8	633.8

Date	Time	Inflow (CFS)	Storage (AC-FT)	Elevation (FT)	Outflow (CFS)
04Jan2017	04:15	355.6	2978.8	4671.8	599.7
04Jan2017	04:30	331.1	2973.8	4671.7	567.7
04Jan2017	04:45	308.0	2969.0	4671.6	537.7
04Jan2017	05:00	286.9	2964.3	4671.6	509.6
04Jan2017	05:15	267.2	2959.8	4671.5	483.5
04Jan2017	05:30	249.1	2955.4	4671.5	459.1
04Jan2017	05:45	232.2	2951.1	4671.4	436.4
04Jan2017	06:00	216.5	2947.0	4671.4	415.3
04Jan2017	06:15	201.9	2942.9	4671.3	395.9
04Jan2017	06:30	188.3	2938.9	4671.3	377.9
04Jan2017	06:45	175.7	2935.1	4671.2	361.5
04Jan2017	07:00	163.9	2931.3	4671.2	346.5
04Jan2017	07:15	152.9	2927.5	4671.1	333.0
04Jan2017	07:30	142.6	2923.8	4671.1	321.2
04Jan2017	07:45	133.1	2920.1	4671.0	311.2
04Jan2017	08:00	124.1	2916.4	4671.0	304.0
04Jan2017	08:15	115.8	2912.7	4671.0	299.7
04Jan2017	08:30	108.1	2908.8	4670.9	295.5
04Jan2017	08:45	100.8	2904.9	4670.9	291.1
04Jan2017	09:00	94.1	2901.0	4670.8	286.8
04Jan2017	09:15	87.8	2897.0	4670.8	282.4
04Jan2017	09:30	81.9	2892.9	4670.7	278.0
04Jan2017	09:45	76.4	2888.9	4670.7	273.5
04Jan2017	10:00	71.2	2884.8	4670.6	269.1
04Jan2017	10:15	66.4	2880.7	4670.6	264.7
04Jan2017	10:30	61.9	2876.6	4670.5	260.3
04Jan2017	10:45	57.7	2872.5	4670.5	255.9
04Jan2017	11:00	53.8	2868.4	4670.4	251.6
04Jan2017	11:15	50.1	2864.3	4670.4	247.3
04Jan2017	11:30	46.7	2860.3	4670.3	243.0
04Jan2017	11:45	43.5	2856.2	4670.3	238.8

Date	Time	Inflow (CFS)	Storage (AC-FT)	Elevation (FT)	Outflow (CFS)
04Jan2017	12:00	40.5	2852.2	4670.2	234.6
04Jan2017	12:15	37.7	2848.2	4670.2	230.4
04Jan2017	12:30	35.1	2844.2	4670.1	226.3
04Jan2017	12:45	32.7	2840.3	4670.1	222.3
04Jan2017	13:00	30.4	2836.4	4670.0	218.3
04Jan2017	13:15	28.3	2832.5	4670.0	214.4
04Jan2017	13:30	26.1	2828.7	4669.9	210.6
04Jan2017	13:45	24.3	2824.9	4669.9	206.8
04Jan2017	14:00	22.5	2821.2	4669.8	203.0
04Jan2017	14:15	20.9	2817.5	4669.8	199.3
04Jan2017	14:30	19.5	2813.8	4669.7	195.7
04Jan2017	14:45	18.1	2810.2	4669.7	192.2
04Jan2017	15:00	16.8	2806.6	4669.6	188.7
04Jan2017	15:15	15.6	2803.1	4669.6	185.3
04Jan2017	15:30	14.5	2799.6	4669.5	181.9
04Jan2017	15:45	13.4	2796.2	4669.5	178.6
04Jan2017	16:00	12.4	2792.8	4669.5	175.4
04Jan2017	16:15	11.5	2789.4	4669.4	172.2
04Jan2017	16:30	10.7	2786.1	4669.4	169.1
04Jan2017	16:45	9.9	2782.9	4669.3	166.1
04Jan2017	17:00	9.1	2779.7	4669.3	163.1
04Jan2017	17:15	8.5	2776.5	4669.3	160.1
04Jan2017	17:30	7.8	2773.4	4669.2	157.3
04Jan2017	17:45	7.2	2770.4	4669.2	154.5
04Jan2017	18:00	6.7	2767.3	4669.1	151.7
04Jan2017	18:15	6.2	2764.4	4669.1	149.0
04Jan2017	18:30	5.7	2761.4	4669.1	146.4
04Jan2017	18:45	5.2	2758.5	4669.0	143.8
04Jan2017	19:00	4.8	2755.7	4669.0	141.2
04Jan2017	19:15	4.4	2752.9	4669.0	138.8
04Jan2017	19:30	4.0	2750.2	4668.9	136.3

Date	Time	Inflow (CFS)	Storage (AC-FT)	Elevation (FT)	Outflow (CFS)
04Jan2017	19:45	3.7	2747.4	4668.9	133.9
04Jan2017	20:00	3.4	2744.8	4668.9	131.6
04Jan2017	20:15	3.1	2742.1	4668.8	129.3
04Jan2017	20:30	2.9	2739.6	4668.8	127.1
04Jan2017	20:45	2.7	2737.0	4668.8	124.9
04Jan2017	21:00	2.5	2734.5	4668.7	122.8
04Jan2017	21:15	2.3	2732.0	4668.7	120.7
04Jan2017	21:30	2.1	2729.6	4668.7	118.6
04Jan2017	21:45	1.9	2727.2	4668.6	116.6
04Jan2017	22:00	1.8	2724.9	4668.6	114.6
04Jan2017	22:15	1.6	2722.6	4668.6	112.7
04Jan2017	22:30	1.5	2720.3	4668.6	110.8
04Jan2017	22:45	1.4	2718.0	4668.5	109.0
04Jan2017	23:00	1.3	2715.8	4668.5	107.2
04Jan2017	23:15	1.2	2713.7	4668.5	105.4
04Jan2017	23:30	1.2	2711.5	4668.4	103.7
04Jan2017	23:45	1.1	2709.4	4668.4	102.0
05Jan2017	00:00	1.0	2707.4	4668.4	100.3

Reservoir "Eightmile Lake" Results for Run "ShortStep8Res"

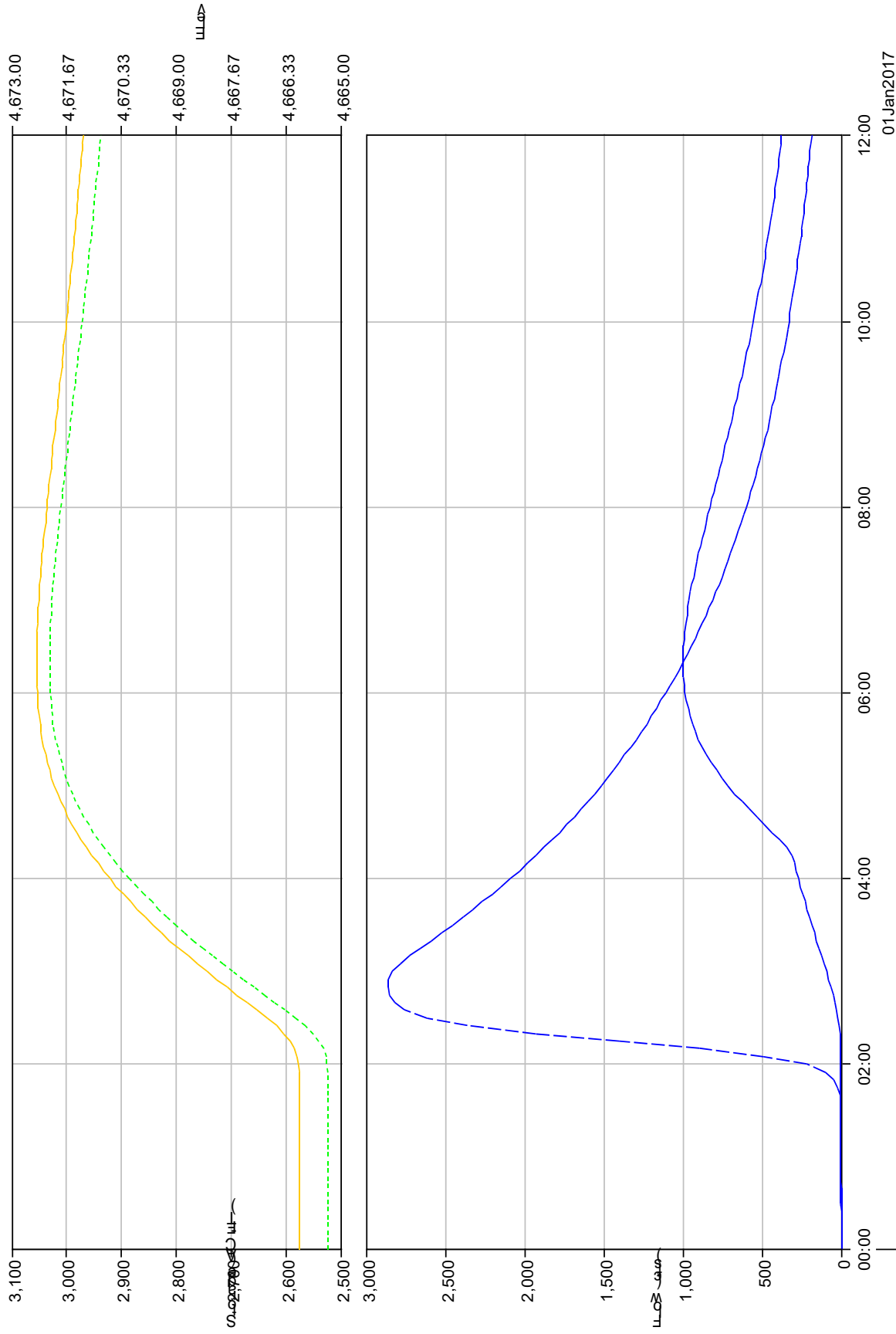

Project: EightmileLake Simulation Run: ShortStep8Res
Reservoir: Eightmile Lake

Start of Run: 01Jan2017, 00:00 Basin Model: EightmileLkResv
End of Run: 01Jan2017, 12:00 Meteorologic Model: ShortStep8Res
Compute Time: 13Apr2017, 07:34:02 Control Specifications: ShortStep8Res

Volume Units: AC-FT

Computed Results

Peak Inflow: 2864.1 (CFS)	Date/Time of Peak Inflow: 01Jan2017, 02:50
Peak Discharge: 997.0 (CFS)	Date/Time of Peak Discharge: 01Jan2017, 06:20
Inflow Volume: 887.3 (AC-FT)	Peak Storage: 3031.4 (AC-FT)
Discharge Volume: 471.9 (AC-FT)	Peak Elevation: 4672.4 (FT)

Project: EightmileLake Simulation Run: ShortStep8Res
 Reservoir: Eightmile Lake

Start of Run: 01Jan2017, 00:00 Basin Model: EightmileLkResv
 End of Run: 01Jan2017, 12:00 Meteorologic Model: ShortStep8Res
 Compute Time: 13Apr2017, 07:34:02 Control Specifications:ShortStep8Res

Date	Time	Inflow (CFS)	Storage (AC-FT)	Elevation (FT)	Outflow (CFS)
01Jan2017	00:00	0.0	2522.6	4666.0	0.0
01Jan2017	00:05	0.0	2522.6	4666.0	0.0
01Jan2017	00:10	0.0	2522.6	4666.0	0.0
01Jan2017	00:15	0.0	2522.6	4666.0	0.0
01Jan2017	00:20	0.0	2522.6	4666.0	0.0
01Jan2017	00:25	0.0	2522.6	4666.0	0.0
01Jan2017	00:30	0.0	2522.6	4666.0	0.0
01Jan2017	00:35	0.0	2522.6	4666.0	0.0
01Jan2017	00:40	0.0	2522.6	4666.0	0.0
01Jan2017	00:45	0.0	2522.6	4666.0	0.0
01Jan2017	00:50	0.1	2522.6	4666.0	0.0
01Jan2017	00:55	0.2	2522.6	4666.0	0.0
01Jan2017	01:00	0.3	2522.6	4666.0	0.0
01Jan2017	01:05	0.4	2522.6	4666.0	0.0
01Jan2017	01:10	0.4	2522.6	4666.0	0.0
01Jan2017	01:15	0.4	2522.6	4666.0	0.0
01Jan2017	01:20	0.5	2522.6	4666.0	0.0
01Jan2017	01:25	0.6	2522.6	4666.0	0.0
01Jan2017	01:30	1.2	2522.6	4666.0	0.0
01Jan2017	01:35	3.1	2522.6	4666.0	0.0
01Jan2017	01:40	8.0	2522.6	4666.0	0.0
01Jan2017	01:45	18.9	2522.7	4666.0	0.0
01Jan2017	01:50	42.5	2522.9	4666.0	0.0
01Jan2017	01:55	93.5	2523.4	4666.0	0.0
01Jan2017	02:00	220.0	2524.5	4666.0	0.1
01Jan2017	02:05	486.7	2526.9	4666.1	0.4

Date	Time	Inflow (CFS)	Storage (AC-FT)	Elevation (FT)	Outflow (CFS)
01Jan2017	02:10	890.5	2531.7	4666.1	1.1
01Jan2017	02:15	1400.0	2539.5	4666.2	2.9
01Jan2017	02:20	1928.2	2551.0	4666.4	6.2
01Jan2017	02:25	2362.8	2565.7	4666.6	11.6
01Jan2017	02:30	2615.9	2582.7	4666.8	19.0
01Jan2017	02:35	2755.5	2601.1	4667.0	28.2
01Jan2017	02:40	2817.7	2620.0	4667.3	38.9
01Jan2017	02:45	2850.4	2639.2	4667.5	50.8
01Jan2017	02:50	2864.1	2658.5	4667.8	63.8
01Jan2017	02:55	2856.8	2677.7	4668.0	77.5
01Jan2017	03:00	2830.6	2696.7	4668.3	91.9
01Jan2017	03:05	2785.1	2715.4	4668.5	106.8
01Jan2017	03:10	2726.1	2733.6	4668.7	122.0
01Jan2017	03:15	2660.0	2751.2	4668.9	137.3
01Jan2017	03:20	2590.5	2768.3	4669.2	152.6
01Jan2017	03:25	2521.4	2784.8	4669.4	167.9
01Jan2017	03:30	2454.0	2800.7	4669.6	183.0
01Jan2017	03:35	2388.5	2816.1	4669.8	198.0
01Jan2017	03:40	2324.7	2830.9	4669.9	212.8
01Jan2017	03:45	2262.9	2845.2	4670.1	227.3
01Jan2017	03:50	2202.7	2859.0	4670.3	241.6
01Jan2017	03:55	2144.1	2872.2	4670.5	255.6
01Jan2017	04:00	2087.4	2885.0	4670.6	269.3
01Jan2017	04:05	2032.0	2897.3	4670.8	282.7
01Jan2017	04:10	1978.4	2909.1	4670.9	295.7
01Jan2017	04:15	1926.2	2920.4	4671.0	311.9
01Jan2017	04:20	1875.4	2931.3	4671.2	346.5
01Jan2017	04:25	1826.1	2941.5	4671.3	389.3
01Jan2017	04:30	1778.0	2951.0	4671.4	436.0
01Jan2017	04:35	1731.4	2960.0	4671.5	484.4
01Jan2017	04:40	1686.1	2968.2	4671.6	532.9

Date	Time	Inflow (CFS)	Storage (AC-FT)	Elevation (FT)	Outflow (CFS)
01Jan2017	04:45	1641.9	2975.9	4671.7	580.6
01Jan2017	04:50	1599.1	2982.9	4671.8	626.7
01Jan2017	04:55	1557.3	2989.3	4671.9	670.6
01Jan2017	05:00	1516.7	2995.1	4672.0	712.0
01Jan2017	05:05	1477.3	3000.4	4672.0	750.6
01Jan2017	05:10	1438.8	3005.1	4672.1	786.2
01Jan2017	05:15	1401.3	3009.4	4672.1	818.7
01Jan2017	05:20	1364.8	3013.1	4672.2	848.3
01Jan2017	05:25	1329.2	3016.5	4672.2	874.8
01Jan2017	05:30	1294.8	3019.4	4672.3	898.3
01Jan2017	05:35	1261.2	3022.0	4672.3	919.0
01Jan2017	05:40	1228.5	3024.1	4672.3	936.8
01Jan2017	05:45	1196.8	3026.0	4672.3	952.1
01Jan2017	05:50	1165.8	3027.5	4672.4	964.9
01Jan2017	05:55	1135.8	3028.8	4672.4	975.3
01Jan2017	06:00	1106.5	3029.7	4672.4	983.5
01Jan2017	06:05	1078.0	3030.5	4672.4	989.6
01Jan2017	06:10	1050.3	3031.0	4672.4	993.8
01Jan2017	06:15	1023.3	3031.3	4672.4	996.2
01Jan2017	06:20	997.1	3031.4	4672.4	997.0
01Jan2017	06:25	971.6	3031.3	4672.4	996.3
01Jan2017	06:30	946.8	3031.0	4672.4	994.2
01Jan2017	06:35	922.6	3030.6	4672.4	990.8
01Jan2017	06:40	899.1	3030.1	4672.4	986.3
01Jan2017	06:45	876.2	3029.4	4672.4	980.8
01Jan2017	06:50	854.0	3028.7	4672.4	974.3
01Jan2017	06:55	832.3	3027.8	4672.4	966.9
01Jan2017	07:00	811.3	3026.8	4672.3	958.8
01Jan2017	07:05	790.7	3025.8	4672.3	950.1
01Jan2017	07:10	770.8	3024.6	4672.3	940.7
01Jan2017	07:15	751.4	3023.4	4672.3	930.8

Date	Time	Inflow (CFS)	Storage (AC-FT)	Elevation (FT)	Outflow (CFS)
01Jan2017	07:20	732.4	3022.1	4672.3	920.5
01Jan2017	07:25	714.1	3020.8	4672.3	909.7
01Jan2017	07:30	696.1	3019.5	4672.3	898.6
01Jan2017	07:35	678.7	3018.0	4672.2	887.2
01Jan2017	07:40	661.7	3016.6	4672.2	875.6
01Jan2017	07:45	645.2	3015.1	4672.2	863.7
01Jan2017	07:50	629.1	3013.6	4672.2	851.7
01Jan2017	07:55	613.4	3012.0	4672.2	839.5
01Jan2017	08:00	598.2	3010.5	4672.1	827.3
01Jan2017	08:05	583.3	3008.9	4672.1	815.0
01Jan2017	08:10	568.8	3007.3	4672.1	802.7
01Jan2017	08:15	554.8	3005.7	4672.1	790.3
01Jan2017	08:20	541.1	3004.0	4672.1	778.0
01Jan2017	08:25	527.7	3002.4	4672.0	765.7
01Jan2017	08:30	514.7	3000.8	4672.0	753.5
01Jan2017	08:35	502.0	2999.1	4672.0	741.3
01Jan2017	08:40	489.7	2997.5	4672.0	729.2
01Jan2017	08:45	477.7	2995.8	4672.0	717.2
01Jan2017	08:50	466.0	2994.2	4671.9	705.3
01Jan2017	08:55	454.6	2992.5	4671.9	693.5
01Jan2017	09:00	443.5	2990.9	4671.9	681.9
01Jan2017	09:05	432.6	2989.2	4671.9	670.4
01Jan2017	09:10	422.1	2987.6	4671.9	659.0
01Jan2017	09:15	411.8	2986.0	4671.8	647.8
01Jan2017	09:20	401.8	2984.3	4671.8	636.7
01Jan2017	09:25	392.1	2982.7	4671.8	625.8
01Jan2017	09:30	382.6	2981.1	4671.8	615.1
01Jan2017	09:35	373.3	2979.5	4671.8	604.5
01Jan2017	09:40	364.3	2977.9	4671.8	594.1
01Jan2017	09:45	355.5	2976.4	4671.7	583.9
01Jan2017	09:50	347.0	2974.8	4671.7	573.8

Date	Time	Inflow (CFS)	Storage (AC-FT)	Elevation (FT)	Outflow (CFS)
01Jan2017	09:55	338.6	2973.2	4671.7	563.9
01Jan2017	10:00	330.5	2971.7	4671.7	554.2
01Jan2017	10:05	322.6	2970.2	4671.7	544.7
01Jan2017	10:10	314.9	2968.6	4671.6	535.4
01Jan2017	10:15	307.3	2967.1	4671.6	526.2
01Jan2017	10:20	300.0	2965.6	4671.6	517.2
01Jan2017	10:25	292.8	2964.1	4671.6	508.4
01Jan2017	10:30	285.9	2962.7	4671.6	499.8
01Jan2017	10:35	279.1	2961.2	4671.5	491.3
01Jan2017	10:40	272.4	2959.7	4671.5	483.0
01Jan2017	10:45	266.0	2958.3	4671.5	474.9
01Jan2017	10:50	259.7	2956.9	4671.5	467.0
01Jan2017	10:55	253.5	2955.4	4671.5	459.2
01Jan2017	11:00	247.6	2954.0	4671.5	451.6
01Jan2017	11:05	241.7	2952.6	4671.4	444.2
01Jan2017	11:10	236.0	2951.2	4671.4	436.9
01Jan2017	11:15	230.5	2949.9	4671.4	429.8
01Jan2017	11:20	225.1	2948.5	4671.4	422.9
01Jan2017	11:25	219.8	2947.1	4671.4	416.1
01Jan2017	11:30	214.7	2945.8	4671.4	409.5
01Jan2017	11:35	209.6	2944.4	4671.3	403.1
01Jan2017	11:40	204.7	2943.1	4671.3	396.8
01Jan2017	11:45	200.0	2941.8	4671.3	390.7
01Jan2017	11:50	195.3	2940.5	4671.3	384.8
01Jan2017	11:55	190.8	2939.2	4671.3	379.0
01Jan2017	12:00	186.3	2937.9	4671.3	373.4

Appendix G

Spillway Channel Capacity Worksheet

Eightmile Lake (Icicle and Peshastin Irrigation Districts)

Channel capacity, compare critical flow with uniform flow

Eightmile Lake-JTS, 11.28.2016

page 1 of 3

Note : Tinted boxes indicate user input required.

Key equations :

Channel geometry :

- Cross section area : $A = b y + Z_{avg} (y^2)$
- Top width : $T = b + (Z_R + Z_L)(y)$
- Wetted perimeter : $P_w = b + (Z_{Rdiag} + Z_{Ldiag})(y)$
- Hydraulic radius : $R_h = A / P_w$
- Hydr. mean depth : $y_m = A / T$
- Side slopes : $Z_{avg} = 1/2 (Z_R + Z_L)$
 $Z_{diag} = (Z_i^2 + 1)^{1/2}$
- Channel bed slope : $S_o = \text{elev.diff.} / L$
- Hydr. friction slope : $S_f = \text{W.L.diff.} / L$

Critical flow conditions :

- Velocity : $V^2 = g * y_m$
- Discharge $Q = V * A * (1 - \% \text{obstr} / 100)$

Uniform flow conditions :

- Velocity : $V = (1.486 / n) R_h^{2/3} S_f^{1/2}$
- Discharge $Q = V * A * (1 - \% \text{obstr} / 100)$

- Froude Number : $Fr^2 = (V^2) / (g * y_m)$
- $Fr_{unif} = V_{unif} / V_{crit}$

Roughness coefficient (n value) for riprap :

- Abt equation, steep bed slope :
 $n = 0.0456 [(D_{50} S_o)^{0.159}]$
- Anderson eqn, mild bed slope :
 $n = 0.0395 [(D_{50})^{1/6}]$

Channel freeboard (Ref: Part IV, pg. 4-16) :

- Required: $FB_{req} = 2.0 + (0.025 * V * y^{1/3})$
- Available: $FB_{avail} = Y_{max} - y_i$
- Excess : $FB_{exs} = (Y_{max} - y_i) - FB_{req}$

Channel reach location and description : **[Verify:]** Spillway down face of dam from crest to downstream toe.

Description of hydraulics : **[Verify:]** Super-critical flow down dam face, draw-down from critical flow at crest.
Hydraulic profile S2 **[verify]**; see Henderson, Open Channel Flow, pg. 111.

Channel geometry :

- bottom width, b = **Input** 99 ft.
- right side slope ZR = **Input** 0.0
- ZRdiag = 1.00
- left side slope ZL = **Input** 0.0
- ZLdiag = 1.00
- Zavg = 0.0
- % obstruction = **Input** 0%
- channel efficiency = 1.00

- Elevations and hydraulic gradients :
- Channel length = **Input** 18 ft.
- Bed, upstream = **Input** 4671.0 ft.
- Bed, downstream = **Input** 4665.0 ft.
- So = 0.333 ft/ft.
- WL, upstream = **Input** 4671.0 ft.
- WL, downstream = **Input** 4665.0 ft.
- Sf = 0.333 ft/ft.

- Bed material = **Input** Concrete
- Riprap D50 = **Input** 1 in.
- riprap n = 0.038 (steep)
- riprap n = 0.026 (mild)
- Roughness n = **Input** 0.030 *Input*
- Ref: **Input** WSDOT / Brater & King / Haan *et al*
- Dam crest elev. = **Input** 4671.0 ft.
- Ymax = **Input** 0.0 ft.

Eightmile Lake (Icicle and Peshastin Irrigation Districts)

Channel capacity, compare critical flow with uniform flow
Eightmile Lake-JTS, 11.28.2016

"y" incr. = Input
0.60 ft.

y (ft.)	A (sq.ft.)	T (ft.)	Pw (ft.)	Rh (ft.)	ym (ft.)	Critical flow :		Uniform flow :	
						Vcrit (ft/sec)	Qcrit (cfs)	Vunif (ft/sec)	Qunif (cfs)
0	0	99	99	0	0	0	0	0	0
0.60	59.40	99.00	100.20	0.59	0.60	4.4	261.1	20.2	1198.8
1.20	118.80	99.00	101.40	1.17	1.20	6.2	738.5	31.8	3775.8
1.80	178.20	99.00	102.60	1.74	1.80	7.6	1356.7	41.3	7363.5
2.40	237.60	99.00	103.80	2.29	2.40	8.8	2088.7	49.7	11801.8
3.00	297.00	99.00	105.00	2.83	3.00	9.8	2919.1	57.2	16987.8
3.60	356.40	99.00	106.20	3.36	3.60	10.8	3837.2	64.1	22846.3
4.20	415.80	99.00	107.40	3.87	4.20	11.6	4835.5	70.5	29318.5
4.80	475.20	99.00	108.60	4.38	4.80	12.4	5907.8	76.5	36356.1
5.40	534.60	99.00	109.80	4.87	5.40	13.2	7049.4	82.2	43918.8
6.00	594.00	99.00	111.00	5.35	6.00	13.9	8256.4	87.5	51971.6

y (ft.)	Vcrit (ft/sec)	FBreq (ft.)	FBexs (ft.)	Vunif (ft/sec)	FBreq (ft.)	FBexs (ft.)	Froude no.	regime
0	0	2	-2	0	2	-2		
0.60	4.4	2.1	-2.7	20.2	2.4	-3.0	4.59	Super
1.20	6.2	2.2	-3.4	31.8	2.8	-4.0	5.11	Super
1.80	7.6	2.2	-4.0	41.3	3.3	-5.1	5.43	Super
2.40	8.8	2.3	-4.7	49.7	3.7	-6.1	5.65	Super
3.00	9.8	2.4	-5.4	57.2	4.1	-7.1	5.82	Super
3.60	10.8	2.4	-6.0	64.1	4.5	-8.1	5.95	Super
4.20	11.6	2.5	-6.7	70.5	4.8	-9.0	6.06	Super
4.80	12.4	2.5	-7.3	76.5	5.2	-10.0	6.15	Super
5.40	13.2	2.6	-8.0	82.2	5.6	-11.0	6.23	Super
6.00	13.9	2.6	-8.6	87.5	6.0	-12.0	6.29	Super

Channel capacity, compare critical flow with uniform flow

Eightmile Lake-JTS, 11.28.2016

page 3 of 3

y (ft.)	Qcrit (cfs)	Qunif (cfs)
0	0	0
0.6	261.1	1198.8
1.2	738.5	3775.8
1.8	1356.7	7363.5
2.4	2088.7	11801.8
3.0	2919.1	16987.8
3.6	3837.2	22846.3
4.2	4835.5	29318.5
4.8	5907.8	36356.1
5.4	7049.4	43918.8
6.0	8256.4	51971.6

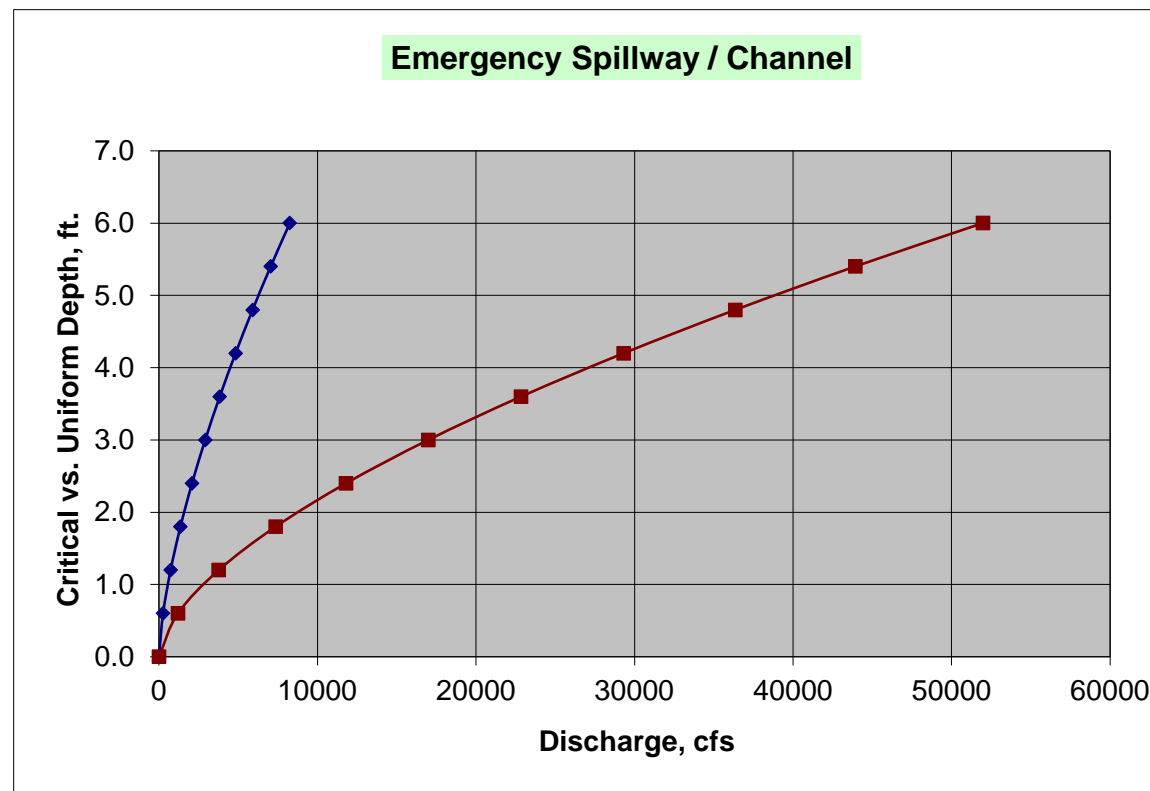

This spreadsheet was developed by engineers in the Dam Safety Office of the Washington State Department of Ecology. It is made available to other engineers as part of our technical assistance efforts.

This spreadsheet is intended for use by Professional Engineers only, or by junior engineers under the supervision of a Professional Engineer. Engineers using this spreadsheet must make sure that these calculations are correctly applied to their project.

Dam owners and design engineers are reminded that they retain full responsibility for the safety of their structures. Also, the design engineer retains full responsibility for the completeness and adequacy of his or her design. Neither the State of Washington, the Department of Ecology, nor Ecology's reviewing engineer(s) are authorized to accept any of the design engineer's professional responsibility and/or potential liability in this regard.

Be sure to read the instruction paper (Instruct.doc) before using this and the accompanying spreadsheets.

If you have any questions regarding the use of this spreadsheet or about Dam Safety's review of your project, please feel free to contact us at :

Washington State Dam Safety Office
Martin Walther, P.E., H/H specialist
E-mail mwal461@ecy.wa.gov
phone 360-407-6420
fax 360-407-7162
mail Washington State Dept of Ecology
Dam Safety Office
PO Box 47600
Olympia, WA 98504
street 300 Desmond Drive
Lacey, WA 98503

Appendix H

Opinion of Probable Project Costs

Eightmile Lake Storage Restoration Feasibility Study

**Opinion of Probable Costs
Eightmile Lake Storage Restoration**

ITEM	UNIT	UNIT COST	QTY	COST (LOW)
Install Monitoring Equipment¹				
Install Staff Gage / Lake Level Monitoring (Transducer Type) ¹	EA	\$0	0	\$0
Install Staff Gage / Discharge Monitoring and Develop Rating ¹	EA	\$0	0	\$0
Subtotal - Install Monitoring Equipment				\$0
Site Preparation				
Clear Wood and Debris from Dam	LS	\$6,000	1	\$6,000
Clearing and Tree Removal	AC	\$12,000	0.5	\$6,000
Install and Maintain Temporary Erosion and Sediment Controls	LS	\$15,000	1	\$15,000
Install and Maintain Dewatering System	LS	\$10,000	1	\$10,000
Install and Maintain Other Pollution Controls	LS	\$5,000	1	\$5,000
Subtotal - Site Preparation				\$42,000
Demolition of Existing Facilities				
Demolish and Remove Ex Concrete/Rock Masonry Dam and Cutoff Walls	LS	\$8,000	1	\$8,000
Demolish and Remove Ex Slide Gate and Appurtenances	LS	\$500	1	\$500
Excavate for Removal of Ex Low-Level Outlet Pipeline	CY	\$50	2,250	\$112,500
Demolish and Remove Ex Low-Level Outlet Pipeline	LS	\$5,000	1	\$5,000
Subtotal - Demolition of Existing Facilities				\$126,000
Install Low-level Outlet and Valves				
Install Buried 30-inch HDPE Low-Level Outlet Pipeline	LF	\$200	418	\$83,600
Install Buried 24-inch HDPE Low-Level Outlet Pipeline	LF	\$150	11	\$1,650
Encase Pipe in Reinforced Concrete Under Dam	CY	\$1,000	28	\$28,000
Excavate Additional Material to Install Low-level Outlet Pipeline	CY	\$50	1,325	\$66,250
Place Processed On-site Bedding Around Low-level Outlet Pipeline	CY	\$30	200	\$6,000
Place Backfill Over Low-level Outlet Pipeline	CY	\$20	3,300	\$66,000
Install Submerged 30-inch HDPE Low-Level Outlet Pipeline	LF	\$250	373	\$93,250
Install Debris Rack at Pipe Inlet	EA	\$5,000	1	\$5,000
Install Air Release Valve	EA	\$3,000	1	\$3,000
Install Vacuum Pump and Connection	EA	\$5,000	1	\$5,000
Install 24-inch Gate Valve for Isolation with Stem Extension	EA	\$45,000	1	\$45,000
Install 24-inch Plug Valve on Low-level Outlet	EA	\$30,000	1	\$30,000
Install Isolation Valve Enclosure	LS	\$10,000	1	\$10,000
Sump Pump for Isolation Valve Enclosure	EA	\$1,000	1	\$1,000
Install Control Valve Enclosure	LS	\$5,000	1	\$5,000
Subtotal - Install Low-level Outlet and Valves				\$449,000
Rebuild Dam and Embankment				
Loose Rock Removal for Dam Construction	CY	\$50	720	\$36,000
Hard Rock Removal for Dam Construction	CY	\$110	1,680	\$184,800
Place Reinforced Concrete for Dam	CY	\$1,000	140	\$140,000
Additional On-site Excavation for Embankment Material	CY	\$50	480	\$24,000
Place Embankment Material	CY	\$40	2,750	\$110,000
Place Gabions with Native Rock and Slush Concrete	CY	\$350	180	\$63,000
Place Native Rock for Armoring	CY	\$40	820	\$32,800
Subtotal - Rebuild Dam and Embankment				\$591,000
Automate Valves to Optimize Releases				
Motorized Valve Actuator	EA	\$20,000	1	\$20,000
Power Supply (Solar Panels and Battery Pack), Controls, Communication	EA	\$25,000	1	\$25,000
Repeater Station ¹	EA	\$0	0	\$0
Subtotal - Automate Valves to Optimize Releases				\$45,000

Eightmile Lake Storage Restoration Feasibility Study

**Opinion of Probable Costs
Eightmile Lake Storage Restoration**

ITEM	UNIT	UNIT COST	QTY	COST (LOW)
Construction Subtotal - All Work²				\$1,253,000
Mobilization Costs (Assumes Use of Helicopter)²				\$515,000
General Mobilization/Demobilization		10.0%		\$125,300
Helicopter Mobilization/Demobilization/Rental	LS	\$390,000	1	\$390,000
ConstructionTotal²				\$1,768,000
Contingency - LOW		20.0%		\$353,600
Contingency - HIGH		40.0%		\$707,200
Engineering, Permitting and Administration		20.0%		\$353,600
Sales Tax		8.2%		\$144,976
Total Project Cost - LOW^{2,3}				\$2,620,000
Total Project Cost - HIGH^{2,3}				\$2,974,000

Notes:

1) Cost associated with installing monitoring equipment and telemetry connection to IPIU are included in the opinion of probable project costs for the Alpine Lakes Optimization and Automation project, as reported in the *Feasibility Study: Alpine Lakes Optimization and Automation* (Aspect 2017) and are not included here.

2) Subtotals and totals are rounded to the nearest \$1,000.

3) Costs are represented in May 2017 dollars. Actual costs may vary based on labor rates, equipment costs, and materials costs at the time of construction.